

READ & SAVE THESE INSTRUCTIONS
INSTALLATION & OPERATION
INSTRUCTIONS FOR: **FCW4100**

CAUTION: Before connecting the fixture to power supply, be sure that the power is switched off.



Headquarters
t 800 900 1730
f 630 889 8106
3609 Swenson Ave.
St. Charles, IL 60174 USA
www.fclighting.com

General Instructions:

1. Mount shade to arm with provided nut and lock-tite.
2. Install lamp into weatherproof assembly supplied.
3. Twist wires from weatherproof lamp assembly together counter-clockwise. Apply supplied lock-tite to the nut fitter of the assembly.
4. Feed the twisted wire through the arm.
5. Attach assembly nut-fitter to the arm - turning it clockwise. Tighten securely.
6. Once fixture assembly is complete mount unit to wall using the detail instructions on page 2.

GENERAL

1. Before starting the installation, disconnect the power by turning of the circuit breaker or by removing the fuse at the fuse box. Turning the power off at the light switch is not sufficient to prevent electrical shock.

2. To ensure the success of the installation, be sure to read these instructions and review the diagrams thoroughly before beginning.

3. All electrical connections must be in accordance with local codes, ordinances, or the national electrical code.

Note: The important safeguards and instructions appearing in this sheet are not meant to cover all possible conditions and situations that may occur.

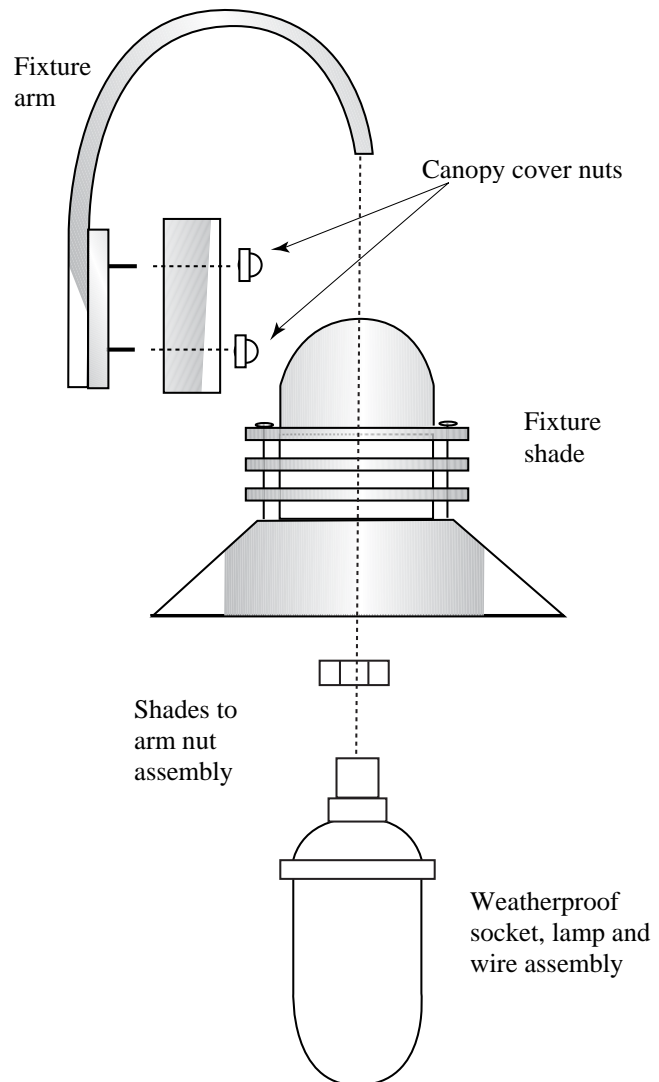

Confidential

This document is the proprietary property of FC Lighting, Inc. Any unauthorized transfer, use, or reproduction is strictly prohibited.

©2003-2004, FC Lighting, Inc.

**INSTRUCTIONS
INSTALLATION**
INSTRUCTIONS FOR:
FCW4100 continued
Page 2

Mounting fixture arm to wall mounting plate: Plate should be mounted to arm allowing access to the fixture wiring for connection to power supply. Fixture arm fits into "u" of wall mounting plate and lines up with holes provided for union. Wall mounting plate is attached to fixture arm by using (2) 1/4-20 bolts. Bolts are run through arm then mounting plate and are locked in place by 1/4-20 keps nuts. The excess bolt is for canopy attachment.

Make wire connections be sure to support fixture during this process.

Apply a substantial bead of silicone caulk to wall forming a closed circle around the outlet box to make seal for wire connections. Also run a bead of silicone around the fixture arm at the top of the wall mounting plate. These steps are critical for a safe and reliable installation. The wall mounting plate will then be mounted flush to wall, not junction box, as fixture weight exceeds what outlet box will support. Four holes are provided for this.

Once securely mounted place canopy over plate and arm assembly. Line up holes in canopy with bolts extending from arm / plate assembly and tighten acorn nuts, provided, on bolts till canopy is secure.

Dimensions:

Canopy - 7" X 7 "
Wall Mtg. plate - 6-7/8" X 5-3/4"
wire way opening is 2-1/2" from bottom of fixture arm. Wire connections will be made approximately 2-1/2" inches from canopy / wall mounting plate top.

