

FCC600 Down Only with Remote Drivers and Battery Backups (-20°C to 55°C)

6" Round wall, pendant or surface mount down cylinder outdoor



FEATURES

- Up to 5000 lm, Up to 100 LPW
- Numerous mounting capabilities
- Clear anti-glare tempered glass lens (IK09)
- Multiple color finishes
- 0-10V 1% Dimming (Standard)
- 1.5G Vibration Tested
- 93 CRI with 2 SDCM

PERFORMANCE

Beam Spread: 15° | 25° | 40° | 50° | 72°
CCT Options: 2700K | 3000K | 3500K | 4000K
CRI: 93 CRI
Consistency: 2 SDCM (Fixture to Fixture)
Lumens: 5000 lm (Max)
Lifetime: > 70,000 hours / L70 or better

PHYSICAL

Mounting: Mounts directly to standard recessed junction box with wall mount or twist-lock canopy. Additional holes allow unit to be attached directly to mounting surface. Not intended for open ceilings or surface mount conduit j-box applications. Recessed j-box must be flush with finished wall or ceiling surface.

Ingress Protection: Continuous silicone gasket to seal out contaminants, IP65 rated for dry, damp or wet locations. SF option rated IP65 for cover ceiling application only.

Finish: Six stage chemical iron phosphate conversion pre-treatment. Polyester powder coat finish, 18 µm Min., 5000hr salt spray test (ASTM B117) compliant with Florida / AAMA 2604 specification.

Warranty: 5-Year limited warranty (refer to website for details)

Housing: Heavy-walled, extruded aluminum housing with high pressure die-cast lens ring and cap with stainless steel hardware.

Lens: IK09 impact compliant, clear anti-glare tempered glass

Vibration Resistance: Compliant with 1.5G ANSI C136.31, Seismic rated AC-156

Weight: 8-12 lbs (Depending on Length)

Operating Temperature: -22°F to 122°F (-30°C to 50°C)

ELECTRICAL

Voltage: Universal 120–277V AC standard, 347V optional

Power Supply: Integral Class II, electronic high-power factor >.90, THD < 20%, FCC Title 47 Part 15 Class A. EldoLED & Lutron optional

Power Consumption: Up to 5000 lm @ 60W

Dimming: **Standard:** 0-10V, 1% Dimming, Optional: ELV | TRIAC | dim to off | DMX | DALI

Certification: CEC Title 24 - JAB Compliant (93 CRI Only)

Standards: cETLus Listed, CE, NOM, and RoHS Compliant. Wet location listed for wall or ceiling mount IP65 Ingress protection. 1.5G (ANSI C136.31) Vibration resistance rated. IK09 (IEC6226) Impact resistance rated. IESNA LM79 Photometric testing by NVLAP accredited test lab. IESNA LM80 LED testing by NVLAP accredited test lab. IESNA TM21 Luminaire lumen depreciation projection to >70,000hrs.

PHYSICAL DIMENSIONS

Fixture	Length (H)
FCC600R-10	10.95" Height
FCC600R-12	12.95" Height
FCC600R-14	14.95" Height
FCC600R-16	16.95" Height
FCC600R-18	18.95" Height
FCC600R-20	20.95" Height

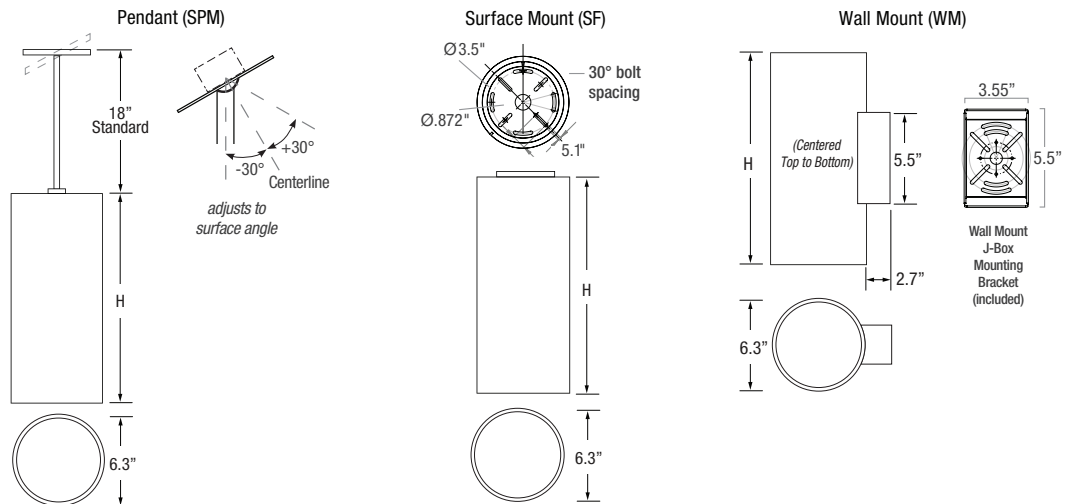

Date: _____
 Type: _____
 Fixture: _____
 Project: _____

Approved: _____

FCC600 Down Only with Remote Drivers and Battery Backups (-20°C to 55°C)

PRODUCT CODE

EXAMPLE: FCC600R-10-SPM-18-UNV-927-05L-BKE-15-ET-CV

MODEL	HEIGHT	MOUNTING	SUSP. LENGTH	VOLTAGE	COLOR	LUMENS	FINISH	OPTIC	DIMMING	OPTIONS	BATTERY
FCC600R											

MODEL
FCC600R
 LED DRIVER REMOTE (INDOOR)
 IP20, IK08, NEMA 1, -20°C to +50°C,
 30' MAX Distance with 12AWG.
 *Consult factory for outdoor remote
 driver only.

HEIGHT

10	10.95" Height
12	12.95" Height
14	14.95" Height
16	16.95" Height
18	18.95" Height
20	20.95" Height

MOUNTING

SPM	Slope Pendant
SF	Surface
WM	Wall

SPM LENGTH

Specify the optional suspension length in inches.
 (Top of fixture to ceiling) (SPM 18" Standard,
 4"-120" Max; 61"-120" w/LD & ET Only and stem
 comes in 2 sections) *Consult factory & price guide
 for other lengths.

VOLTAGE

UNV	Universal 120-277 Volt AC
347V	347 Volt AC

COLOR

927	(93CRI) 2700K
930	(93CRI) 3000K
935	(93CRI) 3500K
940	(93CRI) 4000K

LUMENS nominal

05L	500 lm
10L	1000 lm
15L	1500 lm
20L	2297 lm
25L	2500 lm
30L	3000 lm
35L	3500 lm
40L	4000 lm
45L	4500 lm
50L	5000 lm

FINISH

BKE	Black (AAMA 2604)
BRE	Bronze (AAMA 2604)
GRE	Graphite Grey (AAMA 2604)
SLE	Silver (AAMA 2604)
WHE	White (AAMA 2604)
CCE	Custom Color (AAMA 2604)

OPTIC nominal

15	Spot (15°)
25	Narrow Flood (25°)
40	Mid Flood (40°)
50	Flood (50°)
72	Wide Flood (72°)

w/SOFT FIELD

15S	Spot (15°)
25S	Narrow Flood (25°)
40S	Mid Flood (40°)
50S	Flood (50°)
72S	Wide Flood (72°)

DIMMING

ET	ELV or TRIAC Driver (20L-45L Only) (120V Phase Dimming w/ UNV Driver)
LD	0-10V Dimming, 1% (Standard)

*All drivers listed above are remote.

OPTIONS

CV	Cut-Off Visor (Down Only)
-----------	---------------------------

BATTERY

BBUR	BATTERY BACK-UP & LED DRIVER REMOTE (INDOOR), IP20, IK08, NEMA 1, 0°C to +48°C, 30' MAX Distance with 12AWG (w/UNV Option Only)
BBUX	BATTERY BACK-UP & LED DRIVER REMOTE (OUTDOOR), IP67, IK10, NEMA 4X, -20°C to +55°C, 30' MAX Distance with 12AWG (w/UNV Option Only)
N/A	(Leave Blank for Remote Driver Only without Battery Backup)

Due to continuous development and improvements, specifications are subject to change without notice. FC Lighting, Inc. reserves the right to change lab test details or specifications without notice. Product use certifies agreement to FC Lighting, Inc. terms and conditions. All stated specifications have a tolerance of +/- 7%.

FCC600 Down Only with Remote Drivers and Battery Backups (-20°C to 55°C)

LUMENS nominal

Model	Watts	940
FCC600R	60 W (Max)	500 lm (Min) 5000 lm (Max)

IES Multiplier	
Color	Multiplier
927	0.93
930	0.97
935	0.99
940	1.00

*83CRI±1.15 Consult factory.

TRIAC & ELV Approved Dimmer List	
Manufacturer	Manufacturer Part Number
Lutron	Glyder GLV-600
	Diva DVLV-600P
	Diva DV-600P
	Diva DVELV-600P(303)
	Maestro MALV-600
	Nova T NT-1000
	Nova T NTELV-600
Leviton	SureSlide 6633
	Illumatech IPE04

0-10V Approved Dimmer List	
Manufacturer	Manufacturer Part Number
Lutron	Diva DVSTV-XX
	Diva DVSTV-453PH-WH1
Leviton	Illumatech 010-IP710-DLZ

PHOTOMETRICS

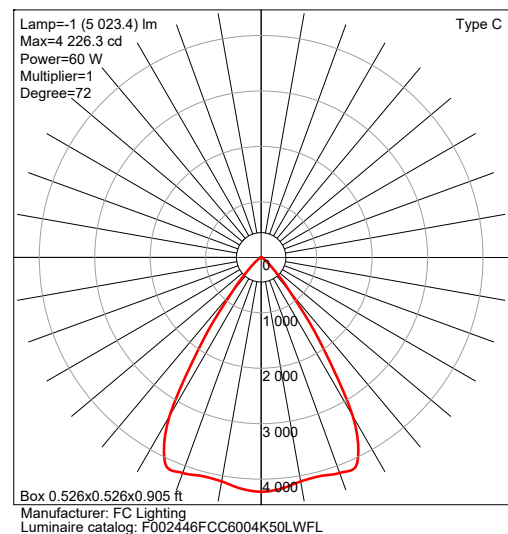
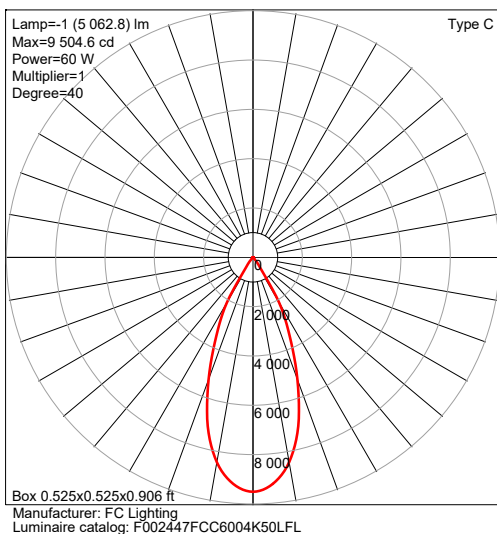
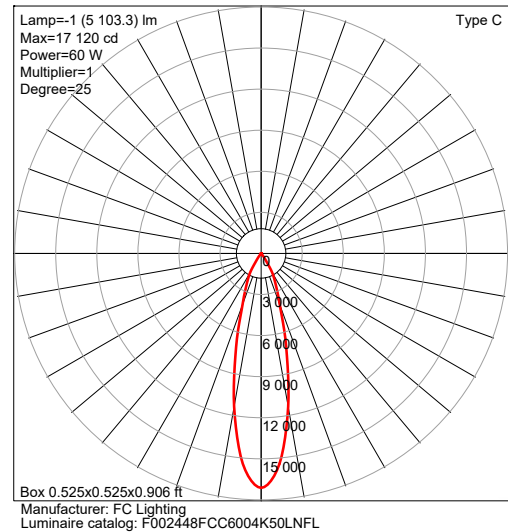
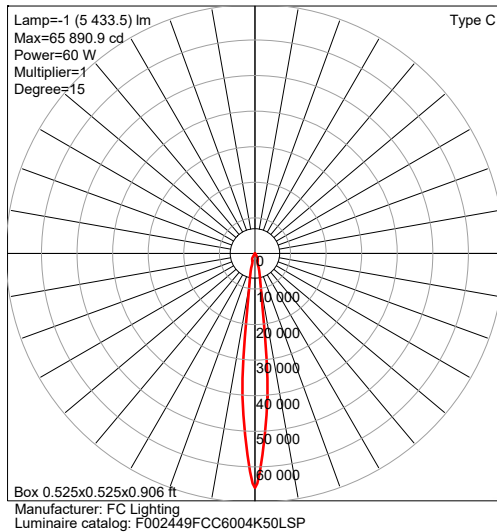

FCC600 Down Only with Remote Drivers and Battery Backups (-20°C to 55°C)

MORE DIMENSIONS

Cutt-Off Visor (CV) (Down Only)

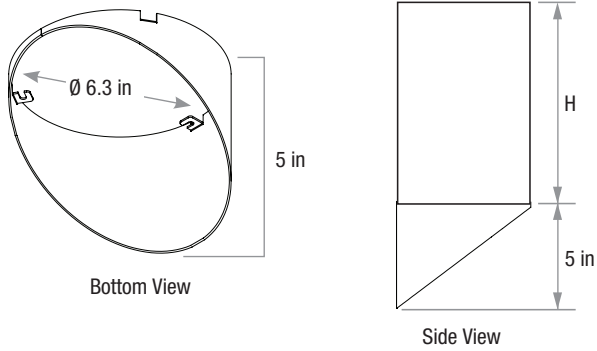

FCC600 Down Only with Remote Drivers and Battery Backups (-20°C to 55°C)

BATTERY BACK-UPS

BBUR - BATTERY BACK-UP & LED DRIVER REMOTE (INDOOR), IP20, IK08, NEMA 1, 0°C to +48°C, 30' MAX Distance with 12AWG (w/UNV Option Only)

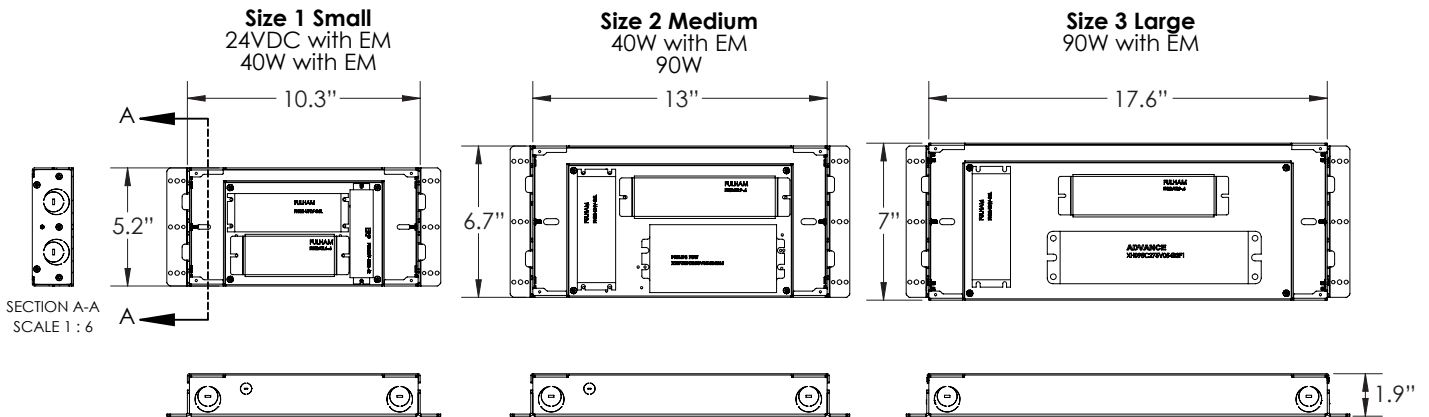

BBUX - BATTERY BACK-UP & LED DRIVER REMOTE (OUTDOOR), IP67, IK10, NEMA 4X, -20°C to +55°C, 30' MAX Distance with 12AWG (w/UNV Option Only)

