

FCB450 (Concrete Pour) - INSTALLATION INSTRUCTIONS

CAUTION: BEFORE CONNECTING THE FIXTURE TO A POWER SUPPLY, MAKE SURE THE POWER IS SWITCHED OFF.

DETAILED ILLUSTRATION

GENERAL:

- Before starting the installation, make sure all electricity has been turned off and electrical breaker has been locked out and tagged out.
- To ensure the success of the installation, be sure to read these instructions and review the diagrams thoroughly before beginning.
- All electrical connections must be in accordance with local codes, ordinances, or the National Electrical Code.

NOTE: The important safeguards and instructions appearing in this manual are not meant to cover all possible conditions and situations that may occur.

1) FOOTING DESIGN:

All footings should be poured to direct water away from the base of the fixture. Drainage should be provided to prevent water from collecting under and around the fixture. Anchors must be located per the dimensions shown. Anchor Bolts are galvanized steel. The unthreaded portion should be in the concrete and the threaded portion should be above the concrete.

2) INSTALL MOUNTING RING:

Remove the mounting plate from the bottom of the fixture by loosening the (4) set screws around the bottom edge of the housing. DO NOT remove screws completely. Once the footing is set and level, install the mounting ring. Place a continuous bead of silicone between the mounting ring and the ground. Tighten nuts snug to hold ring in place. **TIGHTEN EVENLY AND DO NOT OVERTIGHTEN.**

3) WIRING:

Make wiring connections. All wiring connections must be made in accordance with local electrical codes, ordinances, and the National Electric Code.

- Place bollard housing over mounting ring. Tighten the (4) set screws evenly until fixture is held firmly in position.

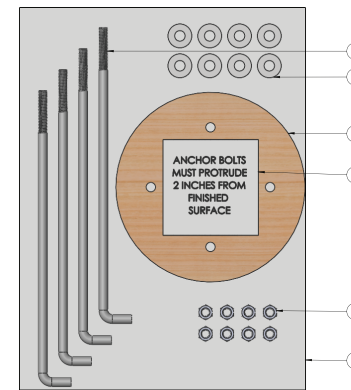
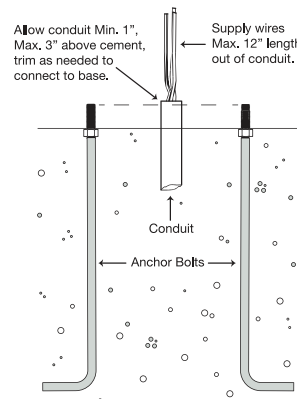
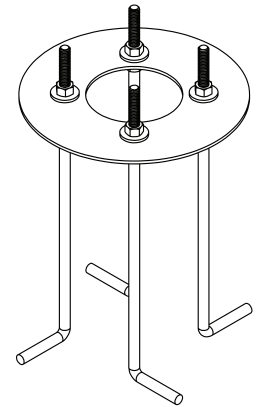
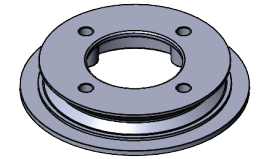
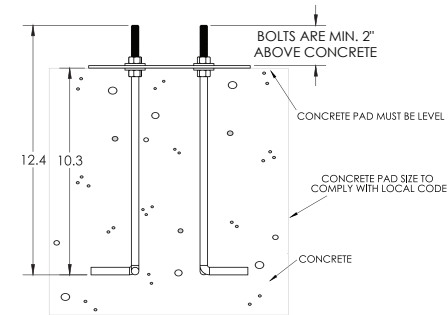
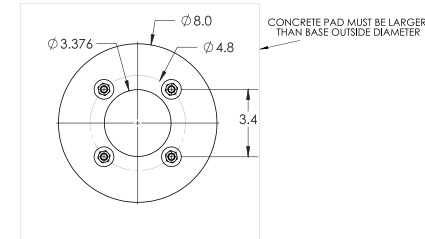
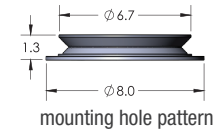
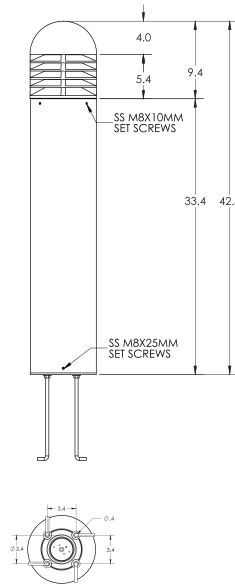

#	ANCHOR BOLT TEMPLATE ASSEMBLY (A00450-01) (Includes below items)	QTY.
1	3/8" x 12" x 1" L Hook Anchor Bolt (94523B-4)	4
2	3/8" Flat Washer H-D Galv Steel	8
3	Anchor Bolt Wood Template	1
4	Anchor Bolt Label	1
5	3/8" Hex Nut H-D Galv Steel	8
6	Plastic Bag, Sealed	1