

Date: _____
 Type: _____
 Luminaire: _____
 Project: _____

Approved: _____

FCC400-RGBW Four-Inch Round Cylinder – Surface or Wall Mount Down Lighting

Standard Drivers without Battery Backup



FEATURES

- Up to 660 lumens (10° beam angle - ALL ON)
- Multiple mounting options
- Clear lens with anti-glare tempered glass (IK08)
- Multiple housing colors
- DMX/RDM control

PERFORMANCE

Beam Spread: 10°, 30°, 60°, 80°
LED Channels: RGBW, RGBW-TW
Lumen Maintenance: L70 > 70,000 hours

PHYSICAL

Mounting: Mounts directly to standard recessed junction box with wall mount or twist-lock canopy. Additional holes allow unit to be attached directly to mounting surface. Not intended for open ceilings or surface mount conduit j-box applications. Recessed j-box must be flush with finished wall or ceiling surface.

Housing: Heavy-walled, extruded aluminum housing with high pressure die-cast lens ring and cap with stainless steel hardware.

Finish: Available in Black, Bronze, Graphite Grey, Silver, White and Custom Colors. Six stage chemical iron phosphate conversion pre-treatment. Polyester powder coat finish, 18 µm minimum, 5,000 hour salt spray test (ASTM B117) compliant with Florida / AAMA 2604 specification.

Warranty: 5-Year limited warranty

Lens: IK08 impact compliant, clear anti-glare tempered glass

Ingress Protection: Continuous silicone gasket to seal out contaminants, IP65 rated for dry, damp or wet locations. SF option rated IP65 for cover ceiling application only.

Weight: 8-12 lbs (Depending on Length)

Operating Temperature: -22°F to 122°F (-30°C to 50°C)

ELECTRICAL

Voltage: Universal 120 - 277 VAC

Power Supply: Integral Class II, electronic high-power factor > .90 @ 120V

Power Consumption: Maximum 15W

Standards: cETLus Listed, tested to UL 1598 and UL 8750 standards / UL Class II / IES LM-79 / LM-80

Vibration Resistance: 1.5 G (ANSI C136.31) rated

Impact Resistance: IK08 (IEC6226) rated

RGBW TECHNOLOGY



PHYSICAL DIMENSIONS

Luminaire	Height
FCC400-10	10.95" Height
FCC400-12	12.95" Height
FCC400-14	14.95" Height
FCC400-16	16.95" Height
FCC400-18	18.95" Height
FCC400-20	20.95" Height

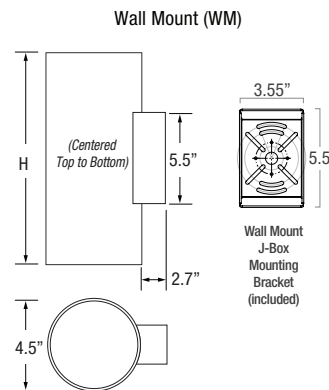
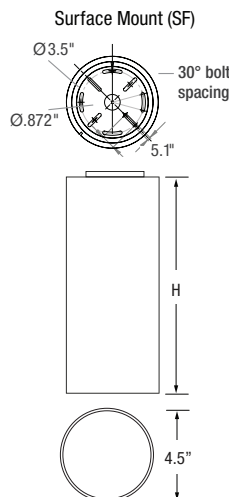

Due to continuous development and improvements, specifications are subject to change without notice. Product use certifies agreement to FC Lighting, Inc. terms and conditions.

FCC400-RGBW Four-Inch Round Cylinder Down Lighting

PRODUCT CODE

EXAMPLE: FCC400-10-SF-UNV-RGBW-BKE-10-DMX

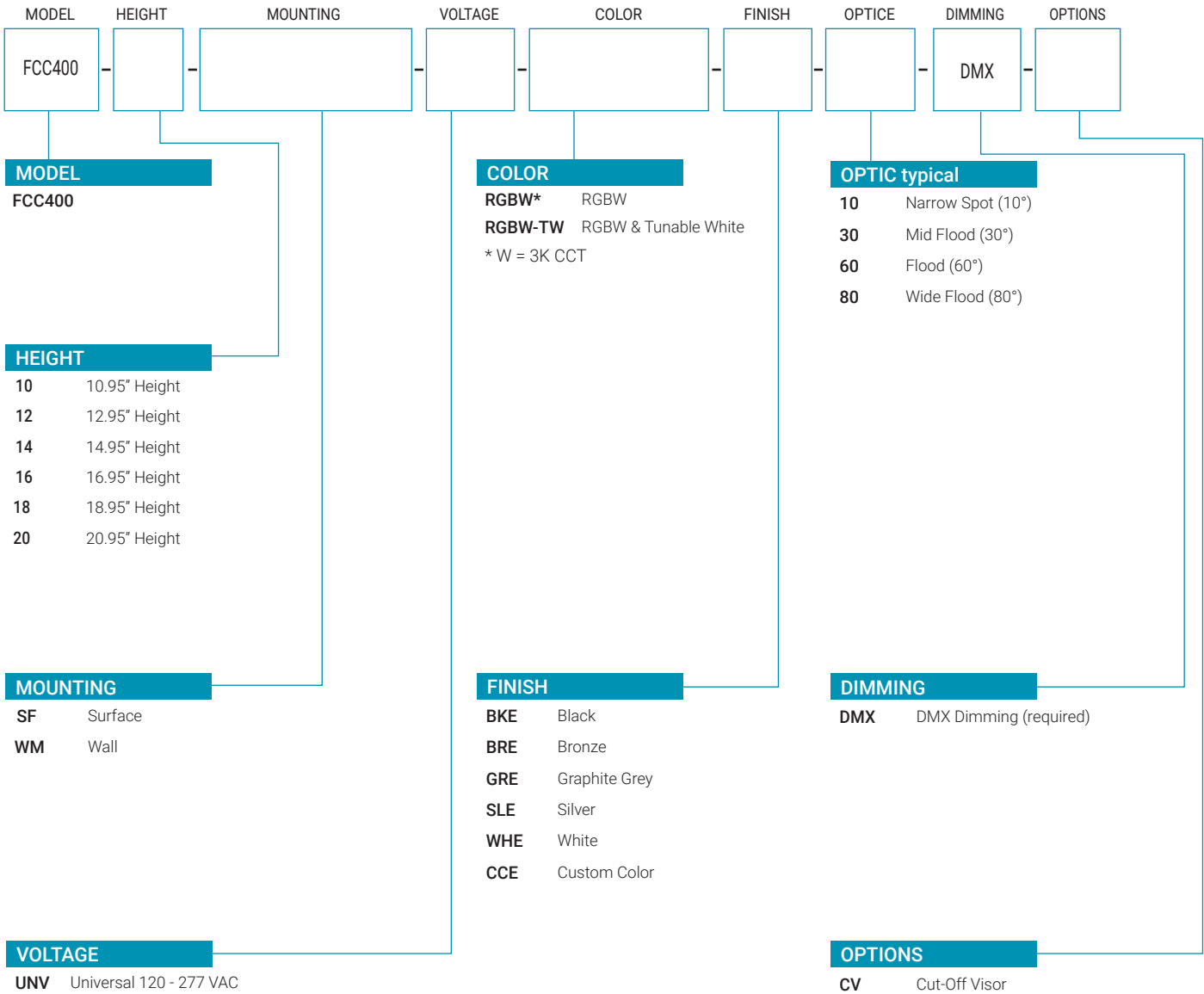

Cable Accessories (order separately)

REQUIRED: Each run requires a Field Installed Data Terminator.

_____ **TCAPFIELD** Field Installed Data Terminator (w/ 120 ohm Resistor)

FCC400-RGBW Four-Inch Round Cylinder Down Lighting

PHOTOMETRICS

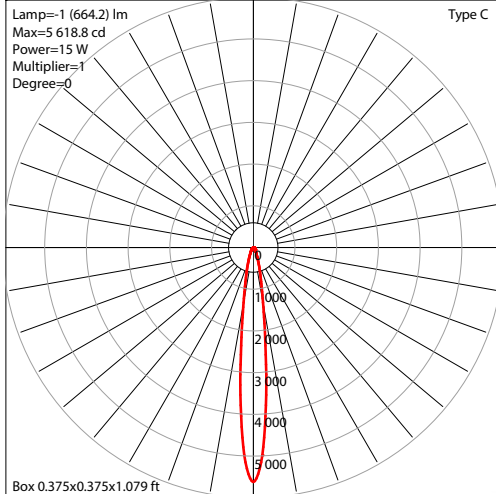

Manufacturer: FC LIGHTING
Luminaire catalog: FCC400-RGBW
Luminaire: FCC400-10-SF-UNV-RGBW-XXX-10-DMX (ALL ON)

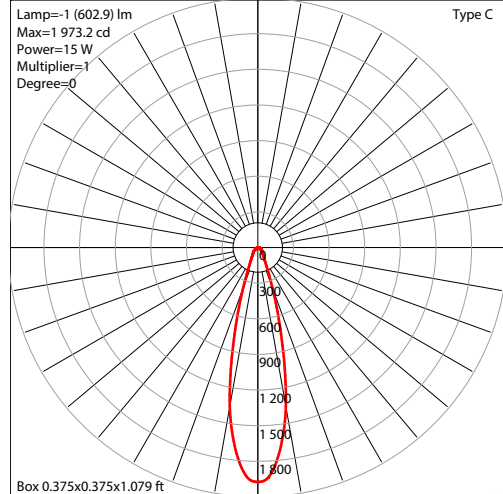

Manufacturer: FC LIGHTING
Luminaire catalog: FCC400-RGBW
Luminaire: FCC400-10-SF-UNV-RGBW-XXX-30-DMX (ALL ON)

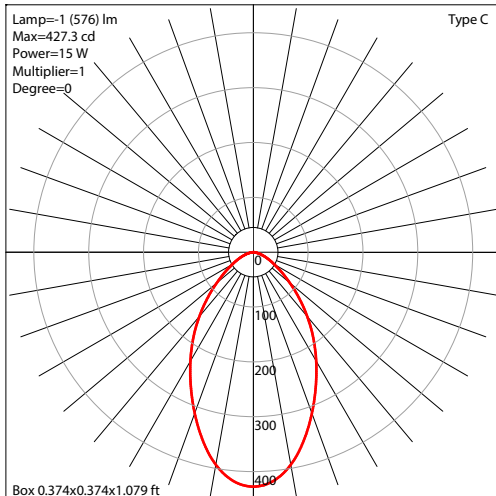

Manufacturer: FC LIGHTING
Luminaire catalog: FCC400-RGBW
Luminaire: FCC400-10-SF-UNV-RGBW-XXX-60-DMX (ALL ON)

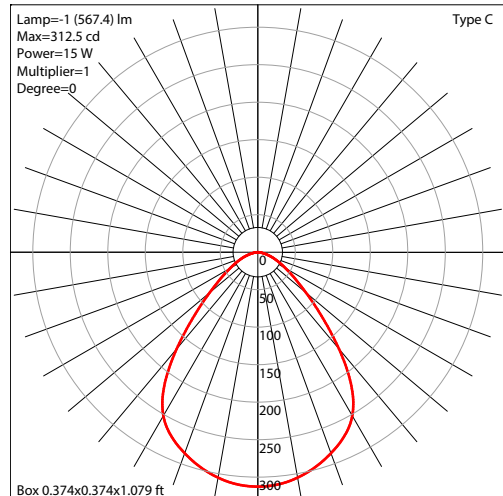

Manufacturer: FC LIGHTING
Luminaire catalog: FCC400-RGBW
Luminaire: FCC400-10-SF-UNV-RGBW-XXX-80-DMX (ALL ON)

FCC400-RGBW Four-Inch Round Cylinder Down Lighting

TECHNOLOGY



ColourQuick

RAPID-MIX COLOR

- Instantaneous Color Mixing – Within 1 inch
- Shortest Distance in Industry for Blending Colors
- 4-in-1 RGBW LED designed to SSL Specifications

ColourLine RGBW luminaires provide the quickest color mixing in the industry. The SSL ColourQuick technology enables our ColourLine Linear Indoor Cove and Graze, as well as, our Outdoor Floods to color-mix almost instantly, within one inch.



ColourClone

TRU-COLOR RGBW MATCHING

- Robotic Calibration of every luminaire provides 1-Step consistency
- Every luminaire has same X, Y color coordinates
- Perfect match for add-ons and replacements

As part of our manufacturing process, SSL Automated Manufacturing Robots calibrate every luminaire to the exact same X,Y color coordinates to provide Step-1 like consistency. This process enables every luminaire to be an exact clone. At the end of the process, a bar code is generated for every board. This allows for exact matching for job add-ons or warranty replacements.



ColourSoft

SMOOTH LOW-TRIM DIMMING

- Flicker-Free Color Transitions and Dimming
- 16-bit performance (65,536 steps) using *only 8-bit addressing*
- SSL Engineered Custom Software and Firmware

Standard dimming technology uses 8-bit resolution for 256 individual steps. Our 32-bit on-board MCU uses SSL developed software to provide 16-bit resolution that allows 65,536 steps of resolution and only use 8-bits of addressing space! We also use a logarithmic delineation of the resolution to concentrate in the lower third of the dimming curve so the low-end dimming and color transitions have zero flicker.



ColourMode

RGBW AND TUNABLE WHITE IN ONE

- SSL Designed Firmware uses 6 DMX Channels
- RGBW and Tunable White (2-Step, > 90 CRI) in One Luminaire
- 5 Distinct Luminaire Personalities for Maximum Flexibility

SSL uses Digital Dual Mode (DDM) technology to provide RGBW and Tunable White in one luminaire! SSL firmware is designed to use 6 DMX channels in the DDM Personality Mode. Maximum Mood Enhancement is available to use for any type of environment. Channels 1-4 are reserved for RGBW. Channels 5-6 are used for White color tuning. Channel 5 controls intensity, channel 6 controls White color.

Scalable

- Full DMX, RDM control capability with latest industry standards
- A wide variety of DMX protocol controls and system accessories
- SSL has many RGBW products utilizing the ColourLine Technology
- Multiple personality settings to enhance RGBW & Tunable White
- Control 1000's of DMX channels with multiple universes & zones
- Powerful luminaires with super optics for long-throw applications
- SSL provides turnkey design and technical integration support

FCC400-RGBW Four-Inch Round Cylinder Down Lighting

WIRING CONFIGURATIONS

SINGLE SEGMENT CONFIGURATION EXAMPLES

STANDARD CONFIGURATION

- 1) DMX-RDM Controller
- 2) DMX Data Cable **DXC-xx** or **CD-xx** (CSC only)
- 3) RGBW Cylinder (with standard 5-Pin cord whip)
- 4) Controller Data Cables/DMX Cables are exterior rated (by others). (Belden 3105A or equivalent) CD-XX cables have male XLR at one end.
- 5) TCAPFIELD (must be installed at the last luminaire in the run)

AC Power - Supplied by others in various methods; to each luminaire separately, in separate conduits, or in the same conduit (Cables with same voltage rating).

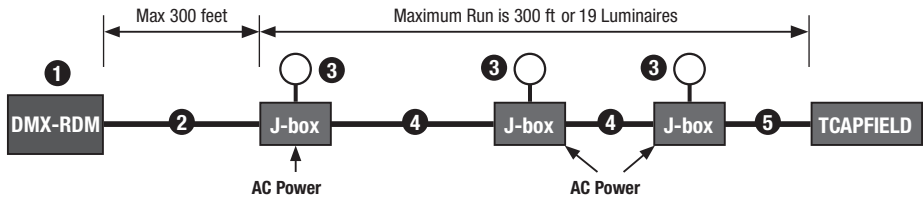

CONTROL COMPONENTS (Indicate the quantity needed for each item.)

- | | |
|---|---|
| _____ PHAROS TPS-5-B 5" Designer Touch Panel Station | _____ DE3BK(WH) Nicolaudie STICK DE-3 Black or White Wall Mount Controller w/color dial |
| _____ PHAROS XPC1 Expert Controller; 512 channels of eDMX/DMX | _____ CW4-WH Nicolaudie STICK White Touch Screen with Internal WiFi |
| _____ PHAROS XPC2 Expert Controller; 1024 channels of eDMX/DMX | _____ GA2WH(BK) Nicolaudie STICK-GA2 White or Black Wall Mount Controller |
| _____ PHAROS XPT-5-B Expert Touch Panel; 5" Display in Black | _____ DXC-25 25 foot DMX cable |
| _____ PHAROS TPC-BB Touch Panel Controller - Black on Black (512 Channels EDMX) | _____ DXC-50 50 foot DMX cable |
| _____ PHAROS EXT Extension for TPC Connectivity | _____ DXC-100 100 foot DMX cable |
| _____ PHAROS LPC1 Lighting Playback Controller 1 (512 channels DMX/eDMX) | _____ CD-10 10 foot controller data cable (for CSC only) |
| _____ PHAROS LPC2 Lighting Playback Controller 2 (1,024 channels DMX/eDMX) | _____ CD-25 25 foot controller data cable (for CSC only) |
| _____ PDX2 Power Data Wiring Box (exterior rated) | _____ CD-50 50 foot controller data cable (for CSC only) |
| _____ PDX-RDS2 Power Data Wiring Box w/2-port splitter | _____ CD-100 100 foot controller data cable (for CSC only) |
| _____ PDX-RDS4 Power Data Wiring Box w/4-port splitter | _____ MV 5900 Multiverse Show Baby DMX Wireless Bridge (Indoor) |
| _____ SCSC-2WH (2BK) White or Black Wall Mount ColourSelect Controller (2 universe) | _____ 7400-5707M Show DMX Vero DMX Wireless Bridge (Exterior) |
| _____ CSC-E ColourSelect Controller (2 universe) | _____ NICOLAUDIE DINA |

Controller Data Cables/DMX Cables listed are exterior rated cables. (Belden 3105A or equivalent) CD-XX cables have male XLR at one end.

FCC400-RGBW Four-Inch Round Cylinder Down Lighting

OPTIONS

Cut-Off Visor (CV)

