

FCC800R Up/Down or Up, Remote Drivers with Battery Backup

8" Round wall mount up/down or up only cylinder outdoor

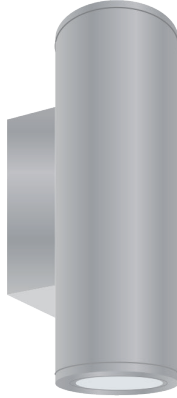

FEATURES

- Up to 7000 lm, Over 100 LPW
- Numerous mounting capabilities
- Clear anti-glare tempered glass lens (IK09)
- Multiple color finishes
- 0-10V 1% Dimming (Standard)
- 1.5G Vibration Tested
- 93 CRI with 2 SDCM

PERFORMANCE

Beam Spread: 15° | 40° | 50° | 72°
CCT Options: 2700K | 3000K | 3500K | 4000K
CRI: 93 CRI
Consistency: 2 SDCM (Fixture to Fixture)
Lumens: 7000 lm
Lifetime: > 70,000 hours / L70 or better

PHYSICAL

Mounting: Mounts directly to standard recessed junction box with wall mount or twist-lock canopy. Additional holes allow unit to be attached directly to mounting surface.

Ingress Protection: Continuous silicone gasket to seal out contaminants, IP65 rated for dry, damp or wet locations

Finish: Six stage chemical iron phosphate conversion pre-treatment. Polyester powder coat finish, 18 µm Min., 5000hr salt spray test (ASTM B117) compliant with Florida / AAMA 2604 specification.

Warranty: 5-Year limited warranty (refer to website for details)

Housing: Heavy-walled, extruded aluminum housing with high pressure die-cast lens ring and cap with stainless steel hardware.

Lens: IK09 impact compliant, clear anti-glare tempered glass

Vibration Resistance: Compliant with 1.5G ANSI C136.31, Seismic rated AC-156

Weight: 8-12 lbs (Depending on Length)

Operating Temperature: -22°F to 122°F (-30°C to 50°C)

ELECTRICAL

Voltage: Universal 120–277V AC standard, 347V optional

Power Supply: Integral Class II, electronic high-power factor >.90, THD < 20%, FCC Title 47 Part 15 Class A. EldoLED & Lutron optional

Power Consumption: Up to 63W (7000 lm)

Dimming: Standard: 0-10V, 1% Dimming, Optional: ELV, TRIAC, dim to off, DMX, DALI

Certification: CEC Title 24 - JA8 Compliant (93 CRI Only)

Standards: cETLus Listed, CE, NOM, and RoHS Compliant. Wet location listed for wall or ceiling mount IP65 Ingress protection. 1.5G (ANSI C136.31) Vibration resistance rated. IK09 (IEC6226) Impact resistance rated. IESNA LM79 Photometric testing by NVLAP accredited test lab. IESNA LM80 LED testing by NVLAP accredited test lab. IESNA TM21 Luminaire lumen depreciation projection to >70,000hrs.

PHYSICAL DIMENSIONS

Fixture	Height (H)
FCC8R12W	12.95" Height (55L Max)
FCC8R14W	14.95" Height (60L Max)
FCC8R16W	16.95" Height
FCC8R18W	18.95" Height
FCC8R20W	20.95" Height
	(All above are Wall Mount Standard)

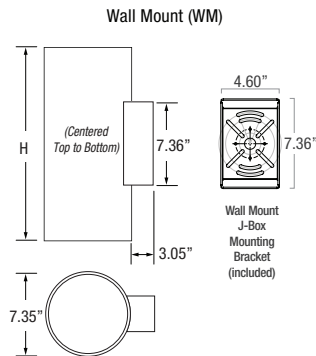

Date: _____
 Type: _____
 Fixture: _____
 Project: _____

Approved: _____

FCC800R Up/Down or Up, Remote Drivers with Battery Backup

PRODUCT CODE

EXAMPLE: FCC8R12W-UNV-927-505L-BKE-D15U15-ET

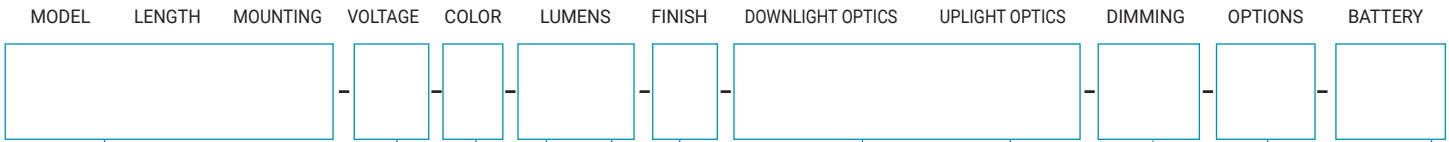

MODEL	
FCC8R12W	12.95" Height (55L Max)
FCC8R14W	14.95" Height (60L Max)
FCC8R16W	16.95" Height
FCC8R18W	18.95" Height
FCC8R20W	20.95" Height
(All above are Wall Mount Standard)	

LED DRIVER REMOTE (INDOOR)
 IP20, IK08, NEMA 1, -20°C to +50°C,
 30' MAX Distance with 12AWG.
 *Consult factory for outdoor remote driver only.

DOWN LUMENS (nominal) UP LUMENS

NO	No Light Option	
5	500 lm	05L
10	1000 lm	10L
15	1500 lm	15L
20	2000 lm	20L
25	2500 lm	25L
30	3000 lm	30L
35	3500 lm	35L
40	4000 lm	40L
45	4500 lm	45L
50	5000 lm	50L
55	5500 lm	55L
60	6000 lm (83CRI Only)	60L
65	6500 lm (83CRI Only)	65L

(65L Max Total output) (Standard Lumen Output Split 50% Up / 50% Down) (Additional driver needed for unequal output selections)

VOLTAGE	
UNV	Universal 120-277 Volt AC
347V	347 Volt AC

COLOR	
927	(93CRI) 2700K
930	(93CRI) 3000K
935	(93CRI) 3500K
940	(93CRI) 4000K
830	(83CRI) 3000K
840	(83CRI) 4000K

FINISH	
BKE	Black (AAMA 2604)
BRE	Bronze (AAMA 2604)
GRE	Graphite Grey (AAMA 2604)
SLE	Silver (AAMA 2604)
WHE	White (AAMA 2604)
CCE	Custom Color (AAMA 2604)

DOWN LIGHT OPTICS (nominal) UPLIGHT OPTICS

D15	Spot (15°) (25L Max)	U15
D25	Narrow Flood (25°)	U25
D40	Mid Flood (40°)	U40
D50	Flood (50°)	U50
D72	Wide Flood (72°)	U72

WITH SOFT FIELD LENS (Below)

D15S	Spot (15°) (25L Max)	U15S
D25S	Narrow Flood (25°)	U25S
D40S	Mid Flood (40°)	U40S
D50S	Flood (50°)	U50S
D72S	Wide Flood (72°)	U72S

DIMMING

ET	ELV or TRIAC Driver (120V Phase Dimming w/ UNV Driver)
LD	0-10V Dimming, 1% (Standard)
ET2	ELV or TRIAC Drivers (Qty. 2) (120V Phase Dimming w/ UNV Drivers)
LD2	0-10V Dimming, 1% (Qty. 2)

*All drivers listed above are remote.

OPTIONS

CV	Cut-Off Visor (Down Only)
-----------	---------------------------

BATTERY

BBUR	BATTERY BACK-UP & LED DRIVER REMOTE (INDOOR), IP20, IK08, NEMA 1, 0°C to +48°C, 30' MAX Distance with 12AWG (w/UNV Option Only)
BBUX	BATTERY BACK-UP & LED DRIVER REMOTE (OUTDOOR), IP67, IK10, NEMA 4X, -20°C to +55°C, 30' MAX Distance with 12AWG (w/UNV Option Only)
N/A	(Leave Blank for Remote Driver Only without Battery Backup)



FCC800R Up/Down or Up, Remote Drivers with Battery Backup

LUMENS nominal

Model	Watts	940
FCC8R	5W (Min)	500 lm (Min)
	53W (Max)	7000 lm (Max)

IES Multiplier	
Color	Multiplier
927	0.93
930	0.97
935	0.99
940	1.00

*83CRI±1.15 Consult factory.

TRIAC & ELV Approved Dimmer List	
Manufacturer	Manufacturer Part Number
Lutron	Glyder GLV-600
	Diva DVLV-600P
	Diva DV-600P
	Diva DVELV-600P(303)
	Maestro MALV-600
	Nova T NT-1000
Leviton	Nova T NTELV-600
	Skylark SLV-600P
	RadioRA2-10ND
	SureSlide 6633
	Illumatech IPE04

0-10V Approved Dimmer List	
Manufacturer	Manufacturer Part Number
Lutron	Diva DVSTV-XX
	Diva DVSTV-453PH-WH1
Leviton	Illumatech 010-IP710-DLZ

PHOTOMETRICS

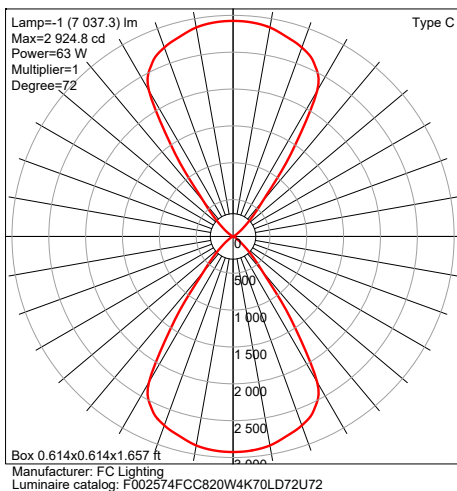
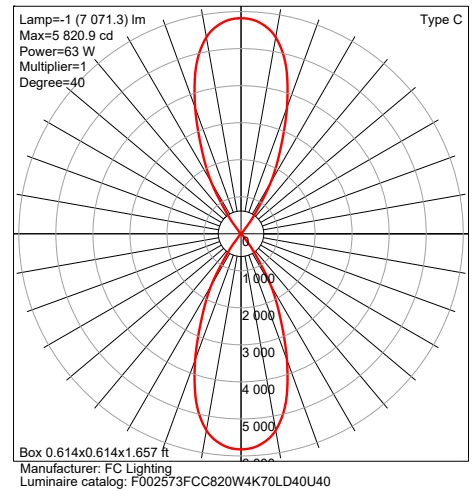
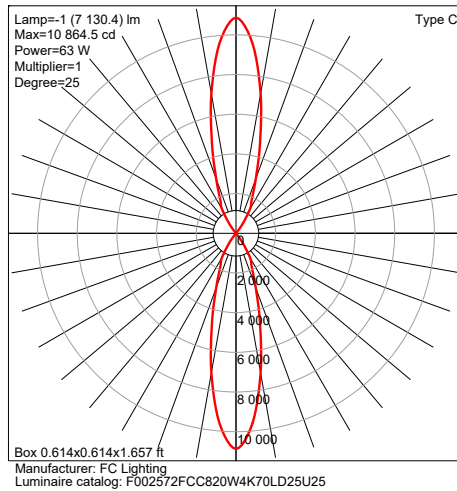
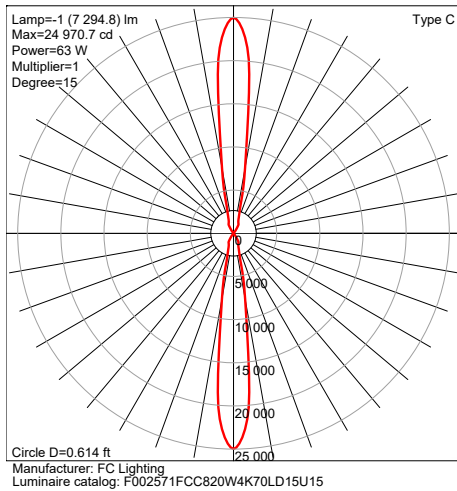

Due to continuous development and improvements, specifications are subject to change without notice. FC Lighting, Inc. reserves the right to change lab test details or specifications without notice. Product use certifies agreement to FC Lighting, Inc. terms and conditions. All stated specifications have a tolerance of +/- 7%.

FCC800R Up/Down or Up, Remote Drivers with Battery Backup

MORE DIMENSIONS

Cutt-Off Visor (CV) (Down Only)

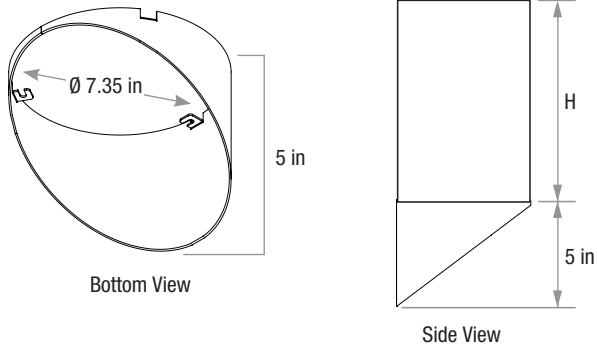

FCC800R Up/Down or Up, Remote Drivers with Battery Backup

BATTERY BACK-UPS

BBUR - BATTERY BACK-UP & LED DRIVER REMOTE (INDOOR), IP20, IK08, NEMA 1, 0°C to +48°C, 30' MAX Distance with 12AWG (w/UNV Option Only)

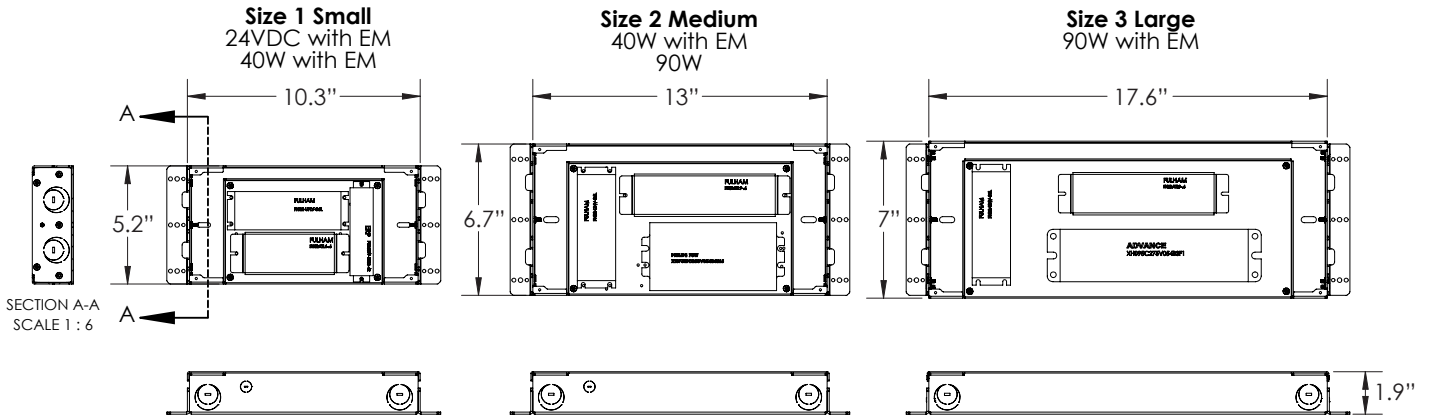

BBUX - BATTERY BACK-UP & LED DRIVER REMOTE (OUTDOOR), IP67, IK10, NEMA 4X, -20°C to +55°C, 30' MAX Distance with 12AWG (w/UNV Option Only)

