

<b>Date:</b>	<b>Approved:</b>
<b>Type:</b>	
<b>Fixture:</b>	
<b>Project:</b>	

## FCD24S

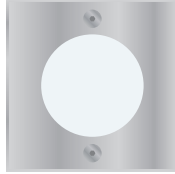

**FCD24S** 2.8 inch square inground recessed fixture with stainless steel faceplate is IP67 rated for exterior use where inground applications are required.



### SPECIFICATIONS

#### PHYSICAL

<b>beam spread</b>	spot (10°)   narrow flood (40°)   flood (50°)   wide flood (70°)
<b>lengths/dimensions [ LxDxH ]</b>	fixture: 2.8" sq x 2.7" D housing: 3.6" D x 2.5" Ø (top)
<b>weight</b>	.5 lbs
<b>housing</b>	marine grade, corrosion resistant, high pressure aluminum (includes mounting sleeve)
<b>lens</b>	3/8" thick clear tempered glass
<b>mounting</b>	concrete pour installation (mounting sleeve included) - jacketed cord, 5ft, 3-18 <sup>GA</sup> ; drainage required (Improperly installed fixtures will void warranty)
<b>ingress protection</b>	IP67 : dry, damp or wet locations with extruded silicone to seal out contaminants
<b>finish</b>	316 machined stainless steel faceplate

#### PERFORMANCE

<b>color temperature</b>	2700K	3000K	3500K	4000K	
<b>lumen output</b>	100 lm				
<b>lifetime</b>	> 70,000 hours / L70 or better				
<b>color consistency</b>	3 SDCM / CRI typical 85   optional: 90+ CRI				
<b>operating temperature</b>	-13°F to 104°F (-25°C to 40°C)				
<b>warranty</b>	5 year limited warranty (refer to website for details)				

#### ELECTRICAL

<b>input voltage</b>	120V AC
<b>power supply</b>	Integral Class II, electronic, high power factor > 94% @120V
<b>certification</b>	ETL/cETL Listed
<b>standards</b>	UL1598/CSA C22.2 No. 250.0; UI 8750/CSA C22.2 No. 250.13/IES LM-79/LM-80
<b>power consumption</b>	4W @ 120V only

Due to continuous development and improvements, specifications are subject to change without notice. FC Lighting reserves the right to change lab test details or specifications without notice. Product use certifies agreement to FC Lighting terms and conditions. FCC Series Cylinder Lights are engineered and produced in our Illinois manufacturing facility.

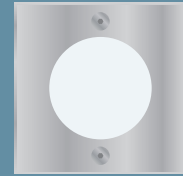

# Ordering Information

## ORDERING INFORMATION

FCD24S	120V		1L		SS	
SERIES	VOLTAGE	CCT	LUMENS	CRI	FINISH	LED OPTICS
<b>FCD24S</b>	<b>120V</b> 120 Volt AC	<b>27K</b> 2700K <b>3K</b> 3000K <b>35K</b> 3500K <b>4K</b> 4000K	<b>1L</b> 100 lm (4W)	<b>CRI85</b> 85 CRI (standard) <b>CRI90</b> 90 CRI	<b>SS</b> Stainless Steel	<b>SP</b> Spot (10°) <b>NFL</b> Narrow Flood (40°) <b>FL</b> Flood (50°) <b>WFL</b> Wide Flood (70°)

Due to continuous development and improvements, specifications are subject to change without notice. FC Lighting reserves the right to change lab test details or specifications without notice. Product use certifies agreement to FC Lighting terms and conditions. FCC Series Cylinder Lights are engineered and produced in our Illinois manufacturing facility.

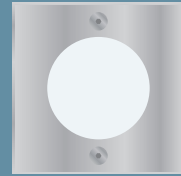

# Physical

PRODUCT DIMENSIONS - STANDARD PRODUCT	
width	2.8" sq
depth	2.7" D

marine grade aluminum housing with 316 stainless steel faceplate

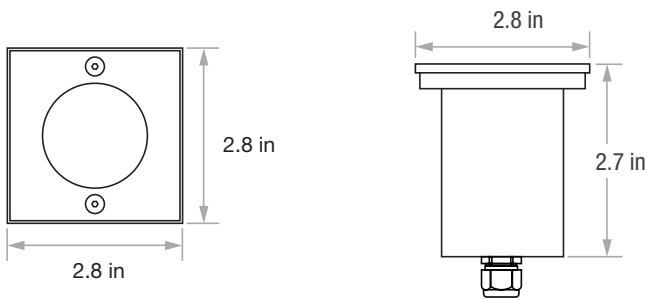

MOUNTING - <i>mounting sleeve included, one per fixture</i>	
PVC housing	2.5" Ø
well housing depth	3.6" D

french drain required for proper installation, see installation instructions

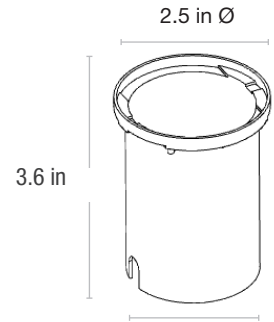

Due to continuous development and improvements, specifications are subject to change without notice. FC Lighting reserves the right to change lab test details or specifications without notice. Product use certifies agreement to FC Lighting terms and conditions. FCC Series Cylinder Lights are engineered and produced in our Illinois manufacturing facility.

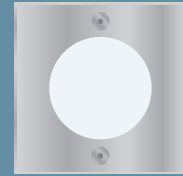

### SPOT DISTRIBUTION

beam spread | 10°

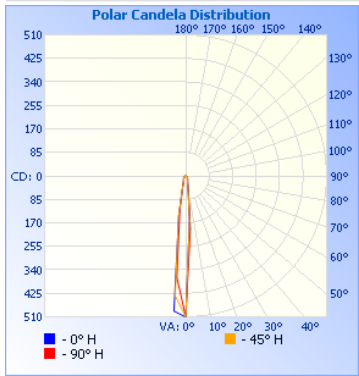

Center Beam fc	Beam Width
1.7ft	0.4 ft
3.3ft	0.7 ft
5.0ft	1.1 ft
6.7ft	1.4 ft
8.3ft	1.8 ft
10.0ft	2.1 ft

**illuminations testing laboratory:**  
Report #2212

### NARROW FLOOD

40°

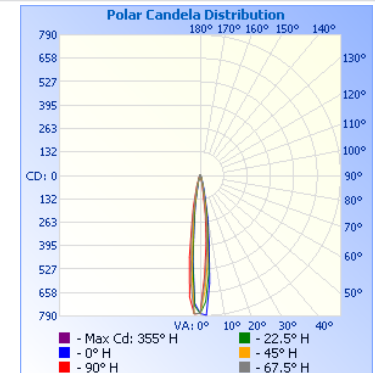

Center Beam fc	Beam Width
1.7ft	0.4 ft
3.3ft	0.8 ft
5.0ft	1.2 ft
6.7ft	1.6 ft
8.3ft	1.9 ft
10.0ft	2.3 ft

**illuminations testing laboratory:**  
Report #2216

### FLOOD DISTRIBUTION

beam spread | 50°

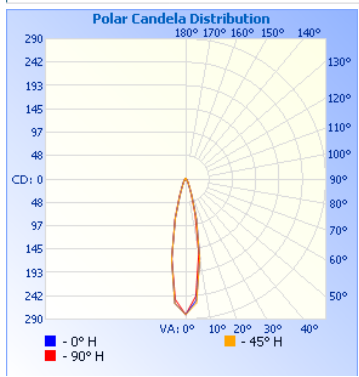

Center Beam fc	Beam Width
1.7ft	0.7 ft
3.3ft	1.4 ft
5.0ft	2.1 ft
6.7ft	2.8 ft
8.3ft	3.4 ft
10.0ft	4.1 ft

**illuminations testing laboratory:**  
Report #2213

### WIDE FLOOD DISTRIBUTION

70°

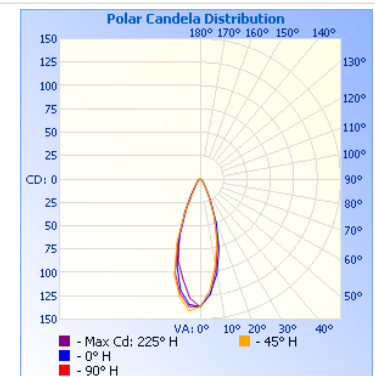

Center Beam fc	Beam Width
1.7ft	1.1 ft
3.3ft	2.2 ft
5.0ft	3.3 ft
6.7ft	4.4 ft
8.3ft	5.5 ft
10.0ft	6.6 ft

**illuminations testing laboratory:**  
Report #2209

Due to continuous development and improvements, specifications are subject to change without notice. FC Lighting reserves the right to change lab test details or specifications without notice. Product use certifies agreement to FC Lighting terms and conditions. FCC Series Cylinder Lights are engineered and produced in our Illinois manufacturing facility.