

Date:	Approved:
Type:	
Fixture:	
Project:	

FCD609R



FCD609R 6 inch round inground recessed fixture with a stainless steel faceplate is IP67 rated for exterior use where inground applications are required.



SPECIFICATIONS

PHYSICAL

beam spread	LED optics: Spot (10°) Narrow Flood (25°) Flood (50°) Wide Flood (70° <i>image free white lens</i>)
dimensions	fixture: 5.5" Ø x 5.1" D PVC housing: 5.3"Ø x 5.9" D
weight	4 lbs
housing	marine grade, corrosion resistant, high pressure aluminum (includes mounting sleeve)
lens	3/8" thick clear tempered, standard. optional: SR = Slip Resistance, etched outer surface
mounting	concrete pour installation (mounting sleeve included) - drainage required (Improperly installed fixtures will void warranty)
ingress protection	IP67 : dry, damp or wet locations with neoprene continuous closed cell gasket to seal out contaminants
finish	316 machined stainless steel faceplate

PERFORMANCE

color temperature	2700K	3000K	3500K	4000K	
lumen output	1300 lm				
lifetime	> 70,000 hours / L90 or better				
color consistency	3SDCM / CRI typical 85 optional: 90+ CRI				
operating temperature	max 143°F (62C)				
warranty	5 year limited warranty (refer to website for details)				

ELECTRICAL

input voltage	Universal 120–277V AC
power supply	Integral Class II, electronic, high power factor > 94% @120V
certifications	ETL/cETL Listed, CEC Title 24 JA8 compliant (only 90CRI complies)
standards	UL1598/CSA C22.2 No. 250.0; UI 8750/CSA C22.2 No. 250.13/IES LM-79/LM-80
power consumption	14W @ 120V - 277V
dimming	standard: no dimming optional: 0-10V (10%)

Due to continuous development and improvements, specifications are subject to change without notice. FC Lighting reserves the right to change lab test details or specifications without notice. Product use certifies agreement to FC Lighting terms and conditions.

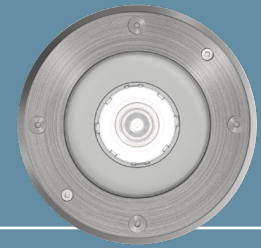

Ordering Information

ORDERING INFORMATION									
FCD609R				13L			SS		
SERIES	VOLTAGE	CCT	LUMENS	CRI	FINISH	LED OPTICS			
FCD609R	120V 120 Volt	27K 2700K	13L 1300 lm (14W)	CRI85 85 CRI (standard)	SS Stainless Steel	SP Spot (10°)	LD 0-10V Dimming (10%)		
	277V 277 Volt	3K 3000K		CRI90 90 CRI		NFL Narrow Flood (25°)	SR Slip Resistance (Frosted Lens)		
		35K 3500K				FL Flood (50°)			
		4K 4000K				WFL Wide Flood (70°) <i>(Image free white lens)</i>			

Due to continuous development and improvements, specifications are subject to change without notice. FC Lighting reserves the right to change lab test details or specifications without notice. Product use certifies agreement to FC Lighting terms and conditions.

 US Commercial Lighting Manufacturer Since 1982

Specification Sheet

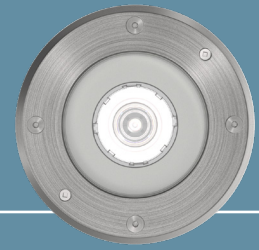

Dimensions

PRODUCT DIMENSIONS - STANDARD PRODUCT | **MOUNTING** - *mounting sleeve included, one per fixture*

width	5.5" Ø
depth	5.1" D

marine grade aluminum housing with 316 stainless steel faceplate

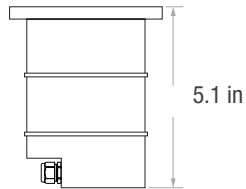
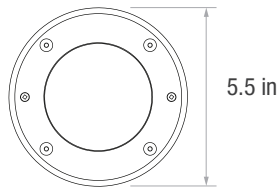

PVC housing	5.3" Ø
well housing depth	5.9" D

french drain required for proper installation, see installation instructions

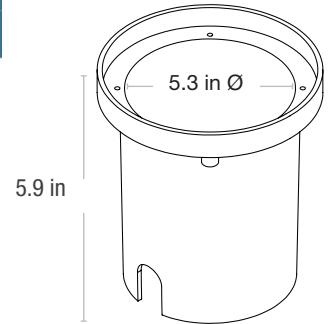

Due to continuous development and improvements, specifications are subject to change without notice. FC Lighting reserves the right to change lab test details or specifications without notice. Product use certifies agreement to FC Lighting terms and conditions.

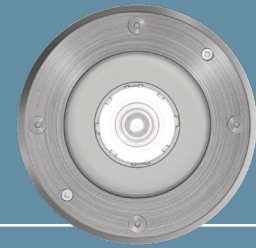

Photometry

SPOT DISTRIBUTION

beam spread | 10°

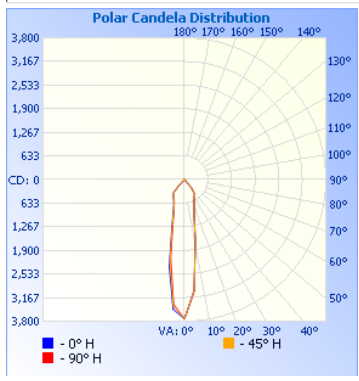

Center Beam fc	Beam Width
1.7ft	1,291 fc 0.6 ft
3.3ft	343 fc 1.3 ft
5.0ft	149 fc 1.9 ft
6.7ft	83.1 fc 2.5 ft
8.3ft	54.2 fc 3.2 ft
10.0ft	37.3 fc 3.8 ft

illuminations testing laboratory:
Report #2218

MID SPOT DISTRIBUTION

25°

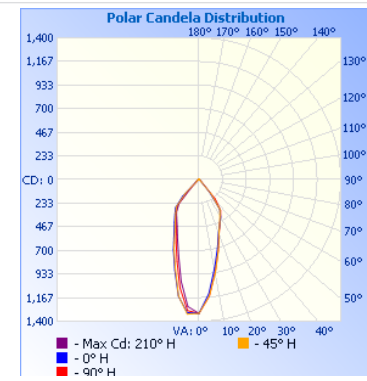

Center Beam fc	Beam Width
1.7ft	457 fc 1.2 ft
3.3ft	121 fc 2.4 ft
5.0ft	52.8 fc 3.6 ft
6.7ft	29.4 fc 4.8 ft
8.3ft	19.2 fc 6.0 ft
10.0ft	13.2 fc 7.2 ft

illuminations testing laboratory:
Report #2219

FLOOD DISTRIBUTION

beam spread | 50°

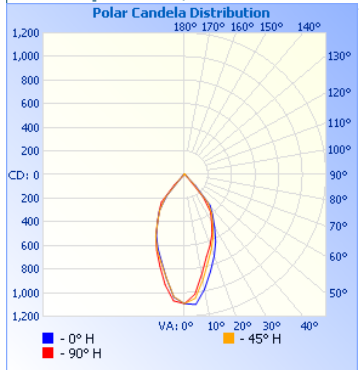

Center Beam fc	Beam Width
1.7ft	378 fc 1.7 ft
3.3ft	100 fc 3.4 ft
5.0ft	43.7 fc 5.1 ft
6.7ft	24.3 fc 6.8 ft
8.3ft	15.9 fc 8.4 ft
10.0ft	10.9 fc 10.2 ft

illuminations testing laboratory:
Report #2220

WIDE FLOOD DISTRIBUTION

70°

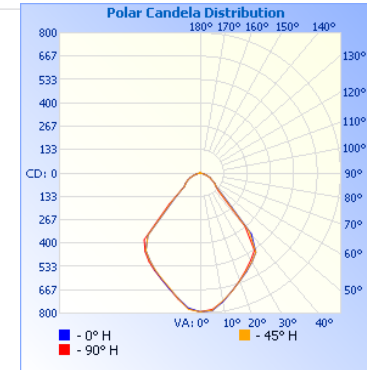

Center Beam fc	Beam Width
1.7ft	205 fc 2.9 ft
3.3ft	54.5 fc 5.7 ft
5.0ft	23.7 fc 8.7 ft
6.7ft	13.2 fc 11.6 ft
8.3ft	8.61 fc 14.4 ft
10.0ft	5.93 fc 17.3 ft

illuminations testing laboratory:
Report #2221

Due to continuous development and improvements, specifications are subject to change without notice. FC Lighting reserves the right to change lab test details or specifications without notice. Product use certifies agreement to FC Lighting terms and conditions.