



Date: _____

Type: _____

Luminaire: _____

Project: _____

Approved: _____

FCSL1103



FCSL1103 10" exterior die-cast aluminum step light with heavy-walled, die-cast louvered faceplate, for masonry or drywall construction is enhanced with improved performance and ease of installation — optimized LED and driver pairing ensures long life featuring a universal back box, snap-fit installation, 316 Stainless Steel tamper-proof hardware and all the options expected from FC Lighting. Offered in 5 different faceplate options, Tri-Dim (0-10V 1%, TRIAC & ELV) dimming and flexible mounting in multiple substrates all backed by our 10-Year Limited Warranty.

SPECIFICATIONS

PHYSICAL

- WC
- WC
- WC
- WC
- WC

dimensions	10" W x 3" H x 3.2" D
weight	3 lbs
housing	Marine grade, corrosion resistant, heavy-walled, high pressure, die-cast aluminum with snap-in IK09 (IEC 62262) impact-resistant Screwless faceplate standard. Optional captive recessed stainless steel tamper resistant screws (TRS option). Back Box is high strength, heavy-walled polycarbonate with UV protection (UL 746C rated f1) and flame rated (UL94 5VA).
lens	Frosted Glass Lens.
mounting	Concrete pour, masonry, solid composite, special construction, and drywall construction mounting kit included. Hanger bar mounting optional. Back box kit can ship in < 48 hours.
ingress protection	Optical, driver unit is IP66, IP67 and IP68 Rated (IEC 60529) dry, damp or wet locations. All seals are injection molded silicone.
faceplate finish	Available in Black, Bronze, Graphite Grey, Silver, White and Custom Colors. Die cast aluminum faceplate. Six stage chemical iron phosphate conversion pre-treatment. Polyester powder coat finish, 18 µm minimum thickness, 5,000 hour salt spray test (ASTM B117) compliant with Florida, AAMA 2604 specification.

PERFORMANCE

- WC

color temperature	2700K, 3000K, 3500K, 4000K, 5000K
lumen output	100 lm, 200 lm
lumen maintenance	L70 > 72,000 hours
color consistency	3 SDCM / 85 CRI
forward throw @ 2 FT high	0.1 fc @ 12 FT forward
side throw @ 2 FT high	0.1 fc @ 16 FT wide
maximum candela	116 CD
BUG rating	B0-U0-G0
operating temperature	-4°F to 122°F (-20°C to 50°C)
warranty	10-Year Limited Warranty

ELECTRICAL

- WC

input voltage	Universal 120 - 277 VAC
power supply	Integral, electronic high-power factor > 90%, THD of ≤ 20%
certifications	cETLus, IC Rated
power consumption	6W (100 lm), 12W (200 lm)
dimming	Tri-Dim (1%, 0-10V, 120 - 277 VAC), (1%, TRIAC & ELV, 120 VAC Only)

WC = World Class Features. See page 2 for details.

Due to continuous development and improvements, specifications are subject to change without notice. FC Lighting reserves the right to change lab test details or specifications without notice. Product use certifies agreement to FC Lighting terms and conditions.

Note: FCSL1140 model shown in cutaway.

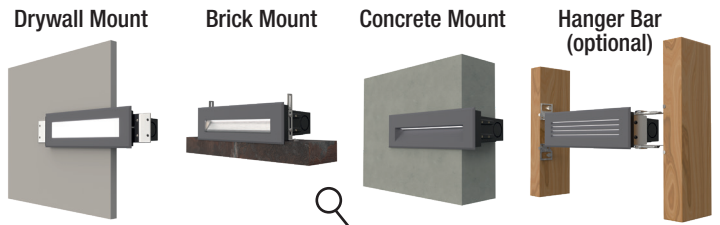

Aesthetic and Robust Fasteners:

Fastener free faceplate offered standard for optimal aesthetics, simply snap in luminaire during final installation for a sleek look unlike any other step light on the market. Ultra corrosion resistant, 316 Stainless Steel hardware comes standard on the exterior including tamper-proof screw option for high-traffic or vandal-prone areas.



Zero Uplight Design:

Full cutoff optics ensure compliance with dark-sky and light pollution-sensitive applications (for selected models).



Extreme Ingress Protection:

First in the industry for IP66, IP67 and IP68 Ratings in a singular product per (IEC 60529) standards. Ensuring ultimate protection in the most severe wet environments including washdowns.

Flexible Mounting Options:

Supports wall and mortar installations with backbox and faceplate configurations for fast, secure installs.



Industry Leading Dimming (Standard):

Equipped as standard with Tri-Dim control (0-10V, TRIAC, ELV) with 1% dimming, providing flexible dimming protocol compatibility without the need for special orders.

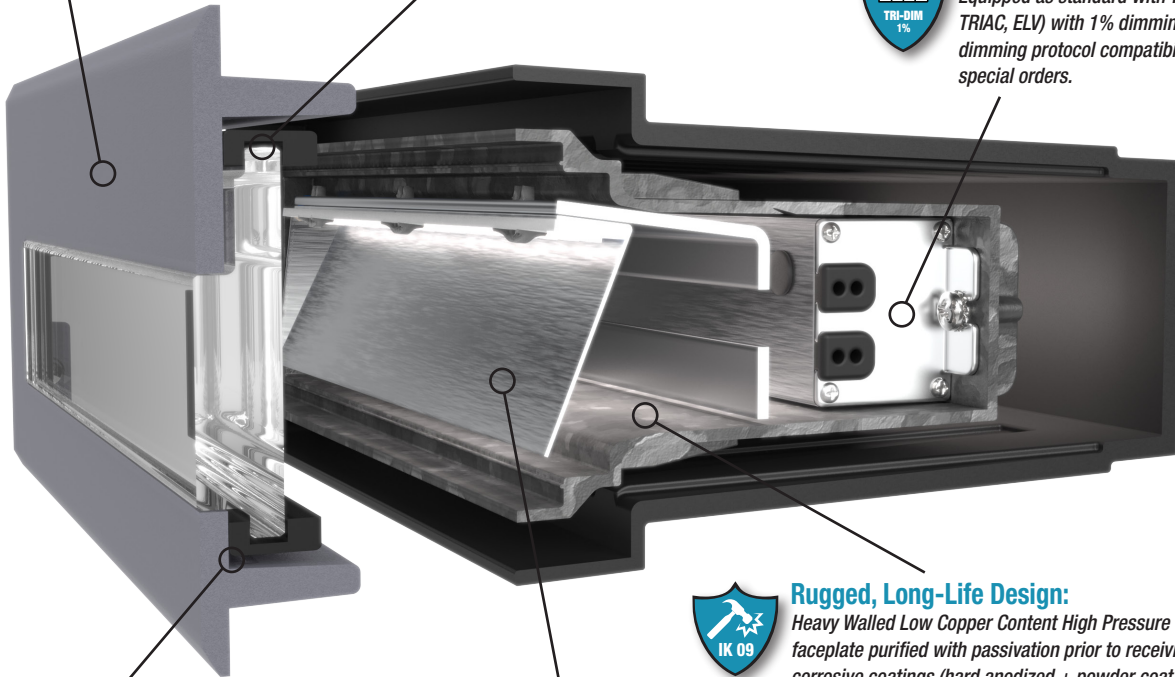

Fail-Safe Waterproofing System:

High-quality inert solid silicone gasketing, breather vents, anti-syphon cables, and waterproof wire nuts ensure complete protection against water ingress and corrosion, extending the life of the sealing system.



Rugged, Long-Life Design:

Heavy Walled Low Copper Content High Pressure Die-cast housing and faceplate purified with passivation prior to receiving superior anti-corrosive coatings (hard anodized + powder coat six-stage, 5K hour salt spray to B117 and AAMA 2604 standards (AAMA 2605 optional). Enclosed with purely opaque inert silicone gasketing and an IK09 (IEC 62262) impact-resistant crystal clear low iron heavy gauge glass to ensure durability in even the most extreme environments.



High-Efficacy Lighting Performance:

Precision German-engineered reflector materials maximize lumens-per-watt efficiency with advanced semi-specular diffusion, delivering multiple tunable output packages that provide up to twice the footcandle levels of competing products reducing luminaire quantities by half on most projects.



Construction-Ready Backbox:

Industry leading heavy-walled polycarbonate back box delivers maximum impact resistance and UV protection (UL 746C F1), combined with the highest flame rating in the industry (UL 94 5VA) and a factory-standard ETL Certified wiring compartment per NEC for primary and thru-wiring, featuring a splatter guard to block debris during rough-in or concrete pours for contractor-ready installation with all mounting options provided in one easy to use kit. Back box kit can ship in < 48 hours upon receipt of order to fast track construction phase on-site prior to factory sealed step light luminaire giving the contractor the ability to finish projects quickly without risk for installer to ensure a seal to maintain wet location rating.

Due to continuous development and improvements, specifications are subject to change without notice. FC Lighting reserves the right to change lab test details or specifications without notice. Product use certifies agreement to FC Lighting terms and conditions.

US Commercial Lighting Manufacturer Since 1982

Specification Sheet

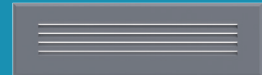

Ordering Information

ORDERING INFORMATION

FCSL1103	UNV		CRI85			TD		
MODEL	VOLTAGE	CCT	CRI	LUMENS ¹	FINISH	DIMMING	OPTIONS	
FCSL1103	UNV	120 - 277 VAC	27K 2700K	CRI85 85 CRI	1L 100 lm (6W)	TD Standard Tri-Dim (1% 0-10V, 120 - 277 VAC), (1% TRIAC & ELV, 120 VAC Only)	TRS Tamper Resistant Screws (Torx Pin)	
			3K 3000K		2L 200 lm (12W)		BRE Bronze	HB* Hanger Bar (Drywall Mounting)
			35K 3500K				GRE Graphite Grey	LBB ² Less Back Box (for shipment separate of Back Box)
			4K 4000K				SLE Silver	
			5K 5000K				WHE White	
					CCE Custom Color			

Footnote:

¹ Typical 4K, CRI85

² Luminaire must be mounted into FC Lighting supplied Back Box shipped with or separate of luminaire.

* Cannot be ordered with LBB option. To purchase with separate backbox (shipped in advance of luminaire), please purchase HSL1100-02-KIT-HB instead.

BACK BOX KITS

HSL1100-02-KIT Back Box Kit - Complete Back Box shipped with mounting kit, shipped in advance of luminaire.

HSL1100-02-KIT-HB Back Box Kit w/ Hanger Bar - Includes (HSL1100-02-KIT) Complete Back Box shipped with mounting kit and Hanger Bar (HB), shipped in advance of luminaire.

PRODUCT DIMENSIONS

width	10" W
height	3" H
depth	3.25" D

MOUNTING

back box width	9.7" W
back box height	2.6" H
back box depth	4" D

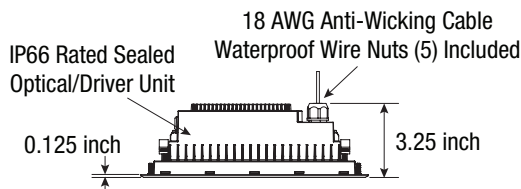

SIDE VIEW

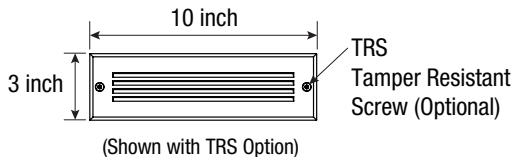

FRONT VIEW

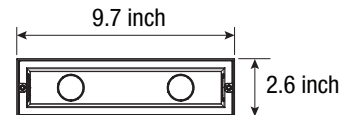
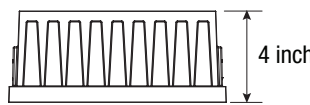

BACK BOX HOUSING
(Injection Molded Plastic)

6-32 Threaded Inserts for Mounting Brackets (Included with Back Box)



(4) Ø3/4 inch (Ø1 1/8 inch True Size) Trade-Size Knockouts (2 on Back, 1 on Each Side)

Due to continuous development and improvements, specifications are subject to change without notice. FC Lighting reserves the right to change lab test details or specifications without notice. Product use certifies agreement to FC Lighting terms and conditions.

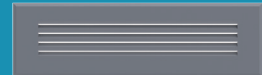

Back Box Assemblies and Options

SHIMS - (8 each) Included with Luminaire

Shims provided to compensate for Back Box misalignment

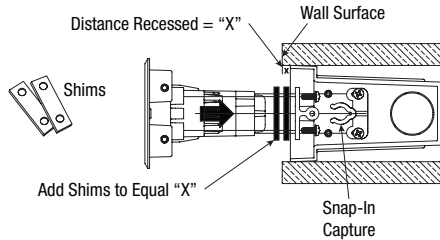

OPTIONAL — Tamper Resistant Screws (TRS)

Torx screws with pin, finished to compliment faceplate finish

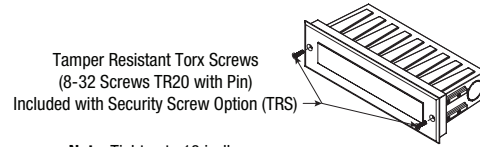

Note: Tighten to 18 in-lbs

MASONRY BRACKETS — Included with Black Box Kit

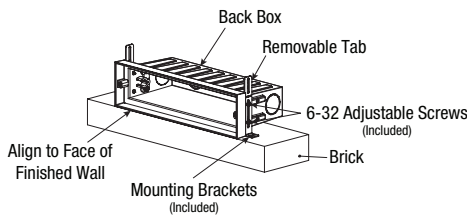

DRYWALL BRACKETS — Included with Black Box Kit

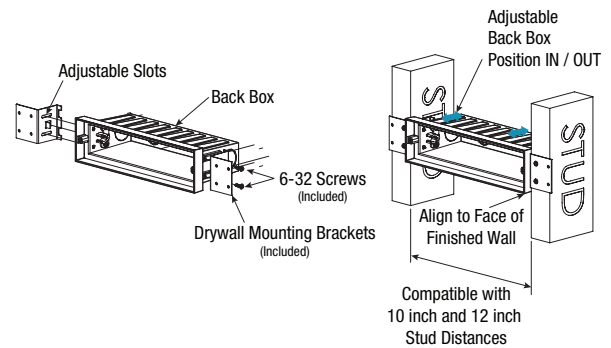

CONCRETE POUR SETUP — Included with Black Box Kit

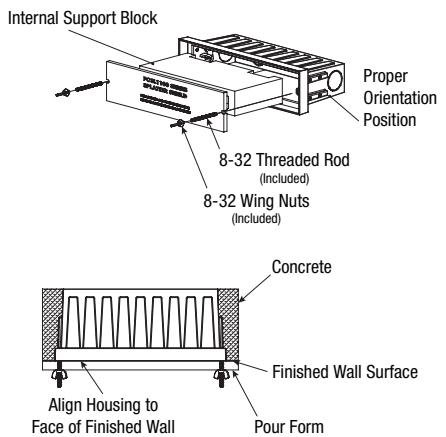

IMPORTANT: Fresh concrete corrodes aluminum with subsequent release of hydrogen. Concrete must be fully cured prior to installation of steplight to prevent any damage.

OPTIONAL — Hanger Bars (HB)

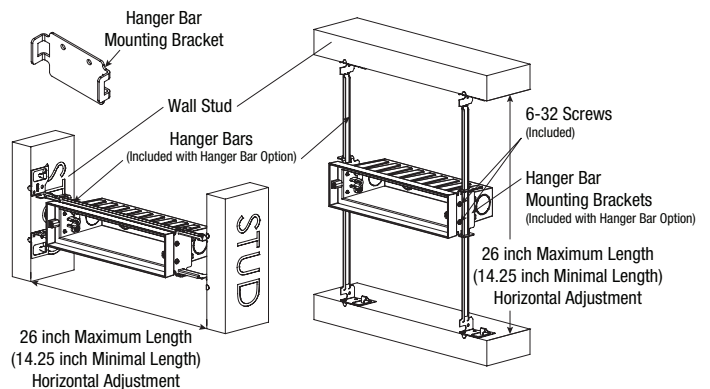

Due to continuous development and improvements, specifications are subject to change without notice. FC Lighting reserves the right to change lab test details or specifications without notice. Product use certifies agreement to FC Lighting terms and conditions.

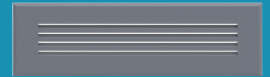

Photometry

OPTICAL DISTRIBUTION

lumen output	100 lm	200 lm
power consumption	6W	12W

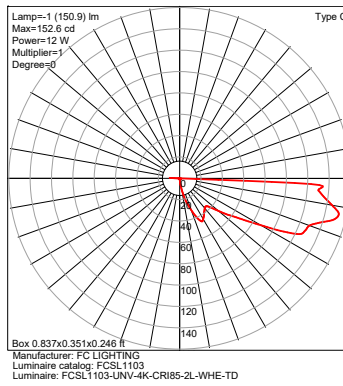
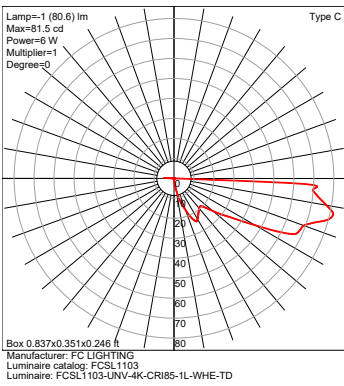

IES MULTIPLIER	
CCT (CRI85)	Multiplier
2700	0.91
3000	0.94
3500	0.96
4000	1.00
5000	1.00

Due to continuous development and improvements, specifications are subject to change without notice. FC Lighting reserves the right to change lab test details or specifications without notice. Product use certifies agreement to FC Lighting terms and conditions.