

<b>Date:</b>	<b>Approved:</b>
<b>Type:</b>	
<b>Fixture:</b>	
<b>Project:</b>	

# FCW3160



**FCW3160** Exterior Decor oval fixture is a die-cast aluminum ceiling or wall mount fixture and is IP65 rated. This ADA compliant, easy to install fixture has an impact resistant lens and provides ample lighting for ceiling, wall or surface mounting. Face options are available in this family of fixtures with finish and color temperature options to specify a wide variety of applications.



## SPECIFICATIONS

PHYSICAL	
<b>dimensions</b>	8.26" H x 13.4" W x 3.7" D
<b>weight</b>	3.5 lbs
<b>housing</b>	Marine grade, corrosion resistant, heavy gauge high pressure die-cast aluminum; captive stainless steel tamper resistant hex head socket screws
<b>lens</b>	Impact and vandal resistant, UV stabilized, white opal, polycarbonate
<b>mounting</b>	Masonry applications use four (4) 0.25" x 0.75" screws with lead anchors (fasteners not included, j-box by others)
<b>ingress protection</b>	IP65 Rated. Suitable for wet, damp or dry location application, with extruded silicone gasket to seal out contaminants
<b>finish</b>	Six stage chemical iron phosphate conversion pre-treatment. Polyester powder coat finish, 18 µm Min., 5000hr salt spray test (ASTM B117) compliant with Florida / AAMA 2604 specification.

PERFORMANCE					
<b>color temperature</b>	2700K	3000K	3500K	4000K	
<b>lumen output</b>	1200 lm   1760 lm   2500 lm   5100 lm				
<b>lifetime</b>	> 70,000 hours / L70 or better				
<b>color consistency</b>	3 SDCM / standard: 85 CRI   optional: 90 CRI				
<b>operating temperature</b>	-13°F to 104°F (-25°C to 40°C)				
<b>junction temperature</b>	73°C @ T <sup>a</sup> 25°C				
<b>warranty</b>	5-Year limited warranty (refer to website for details)				

ELECTRICAL	
<b>input voltage</b>	Universal 120 - 277 VAC   optional: 347 VAC (Integral)
<b>power supply</b>	Integral Class II, electronic high-power factor > 94% @ 120V
<b>certifications</b>	ETL/cETL Listed, CEC Title 24 JA8 compliant (only 90CRI complies), ADA Compliant
<b>standards</b>	UL 1598 / CSA C22.2 No. 250.0; UL 8750 / CSA C22.2 No. 250.13; Class II / IES LM-79 / LM-80
<b>power consumption</b>	61W @ 120V (maximum)
<b>dimming</b>	Standard: 0-10V (1%)   Optional: ELV (120V Only) / DMX (Integral) / DALI (Integral)

Due to continuous development and improvements, specifications are subject to change without notice. FC Lighting reserves the right to change lab test details or specifications without notice. Product use certifies agreement to FC Lighting terms and conditions. FCC Series Cylinder Lights are engineered and produced in our Illinois manufacturing facility.



## Ordering Information

### ORDERING INFORMATION

FCW3160																
SERIES	VOLTAGE		CCT		CRI		LUMENS		FINISH		OPTIONS					
FCW3160	UNV	120 - 277 VAC		27K	2700K	CRI85	85 CRI (Standard)		12L	1200 lm (15W)		BKE	Black	LD	0-10V Dimming (10%)	
	120V	120 VAC		3K	3000K	CRI90	90 CRI		18L	1760 lm (22W)		BRE	Bronze	ELV*	ELV Dimming* (120V Only)	
	347V	347 VAC (Remote)		35K	3500K				25L	2500 lm (30.5W)		GRE	Graphite Grey	DMX	DMX Dimming (Integral)	
				4K	4000K				51L	5100 lm (61W)		SLE	Silver	DALI	DALI Dimming (Integral)	
												WHE	White			
												CCE	Custom Color			

### REMOTE DRIVER & BATTERY BACKUP

FCW3160R																
SERIES	VOLTAGE		CCT		CRI		LUMENS		FINISH		OPTIONS					
FCW3160R <sup>†</sup>	UNV	120 - 277 VAC		27K	2700K	CRI85	85 CRI (Standard)		12L	1200 lm (15W)		BKE	Black	LD	0-10V Dimming (10%)	
				3K	3000K	CRI90	90 CRI		18L	1760 lm (22W)		BRE	Bronze	DMX	DMX Dimming (Remote Only)	
				35K	3500K				25L	2500 lm (30.5W)		GRE	Graphite Grey	DALI	DALI Dimming (Remote Only)	
				4K	4000K				51L	5100 lm (61W)		SLE	Silver	BBUR <sup>1</sup>	Battery Backup Remote (Indoor)	
												WHE	White	BBUX <sup>2</sup>	Battery Backup Remote (Outdoor)	
												CCE	Custom Color	N/A	Leave Blank for Remote Driver Only (without Battery Backup)	

<sup>†</sup> LED DRIVER REMOTE (INDOOR) IP20, IK08, NEMA 1, -20°C to +50°C, 30' MAX Distance with 12AWG.

\* Consult factory for outdoor remote driver only.

<sup>1</sup> Battery Back-up & LED Driver Remote (INDOOR), IP20, IK08, NEMA 1, 0°C to +48°C, 30' MAX Distance with 12AWG (w/UNV Option Only)

<sup>2</sup> Battery Back-up & LED Driver Remote (OUTDOOR), IP67, IK10, NEMA 4X, -20°C to +55°C, 30' MAX Distance with 12AWG (w/UNV Option Only)

Due to continuous development and improvements, specifications are subject to change without notice. FC Lighting reserves the right to change lab test details or specifications without notice. Product use certifies agreement to FC Lighting terms and conditions. FCC Series Cylinder Lights are engineered and produced in our Illinois manufacturing facility.



# Dimensions

**PRODUCT DIMENSIONS - STANDARD PRODUCT** | **MOUNTING - j-box sold by others**

<b>width</b>	8.26" W
<b>height</b>	13.4" H
<b>depth</b>	3.7" D

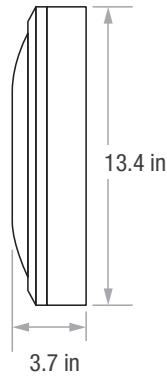
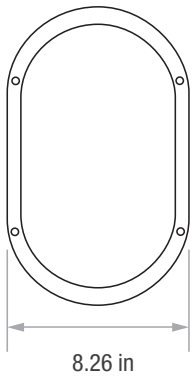

<b>mounting plate width</b>	8" W
-----------------------------	------

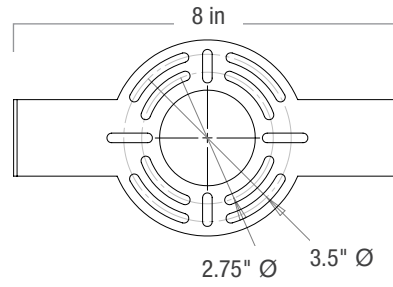

8 inch mounting plate:  
mounts flush to surface,  
included with fixture.

3.5" or 2.75" mounting diameter

Due to continuous development and improvements, specifications are subject to change without notice. FC Lighting reserves the right to change lab test details or specifications without notice. Product use certifies agreement to FC Lighting terms and conditions. FCC Series Cylinder Lights are engineered and produced in our Illinois manufacturing facility.



# Photometry

## OPTICAL DISTRIBUTION

<b>lumen output</b>	5100 Lm @ 4000K
<b>power consumption</b>	62W

Illuminance at a Distance		
	Center Beam fc	Beam Width
1.7R	25.5 fc	3.4 ft 3.4 ft
3.3R	6.78 fc	6.5 ft 6.5 ft
5.0R	2.95 fc	9.9 ft 9.9 ft
6.7R	1.64 fc	13.3 ft 13.3 ft
8.3R	1.07 fc	16.5 ft 16.5 ft
10.0R	0.74 fc	19.8 ft 19.8 ft

■ Vert. Spread: 89.5°  
■ Horiz. Spread: 89.5°

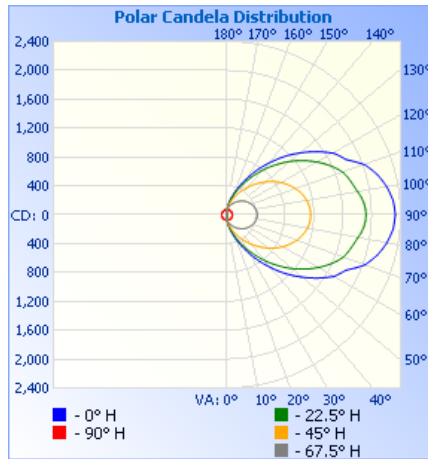

**iti illuminations testing laboratory :**

FCW3160

FIND IES FILES ON FCLIGHTING.COM

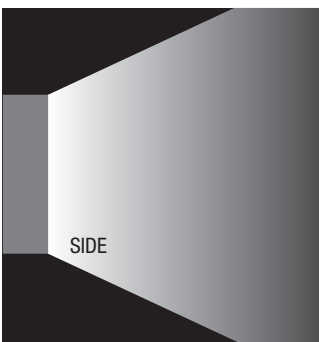

Due to continuous development and improvements, specifications are subject to change without notice. FC Lighting reserves the right to change lab test details or specifications without notice. Product use certifies agreement to FC Lighting terms and conditions. FCC Series Cylinder Lights are engineered and produced in our Illinois manufacturing facility.

 US Commercial Lighting Manufacturer Since 1982

**Specification Sheet**

**BATTERY BACK-UPS**

**BBUR - BATTERY BACK-UP & LED DRIVER REMOTE (INDOOR), IP20, IK08, NEMA 1, 0°C to +48°C, 30' MAX Distance with 12AWG (w/UNV Option Only)**

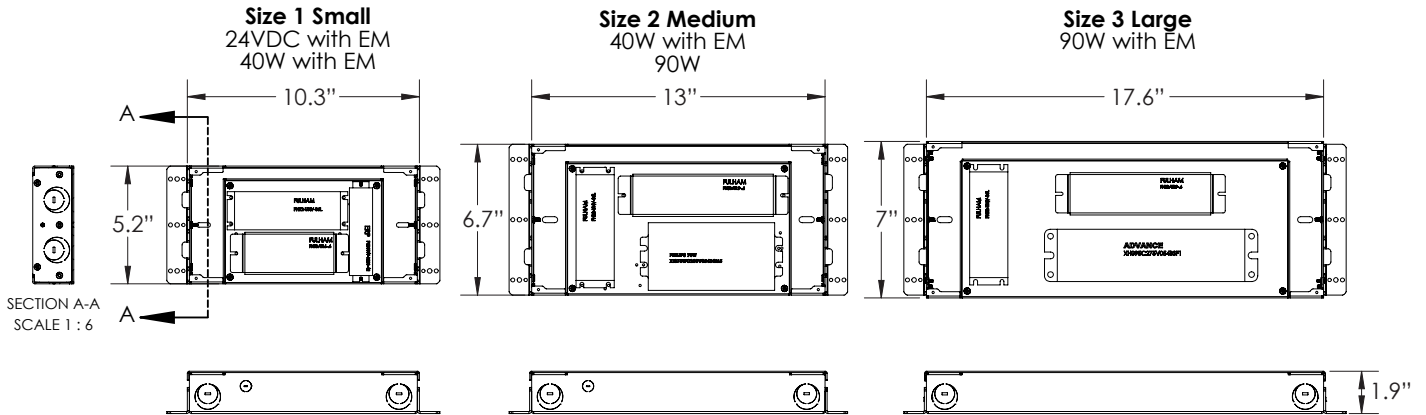

**BBUX - BATTERY BACK-UP & LED DRIVER REMOTE (OUTDOOR), IP67, IK10, NEMA 4X, -20°C to +55°C, 30' MAX Distance with 12AWG (w/UNV Option Only)**

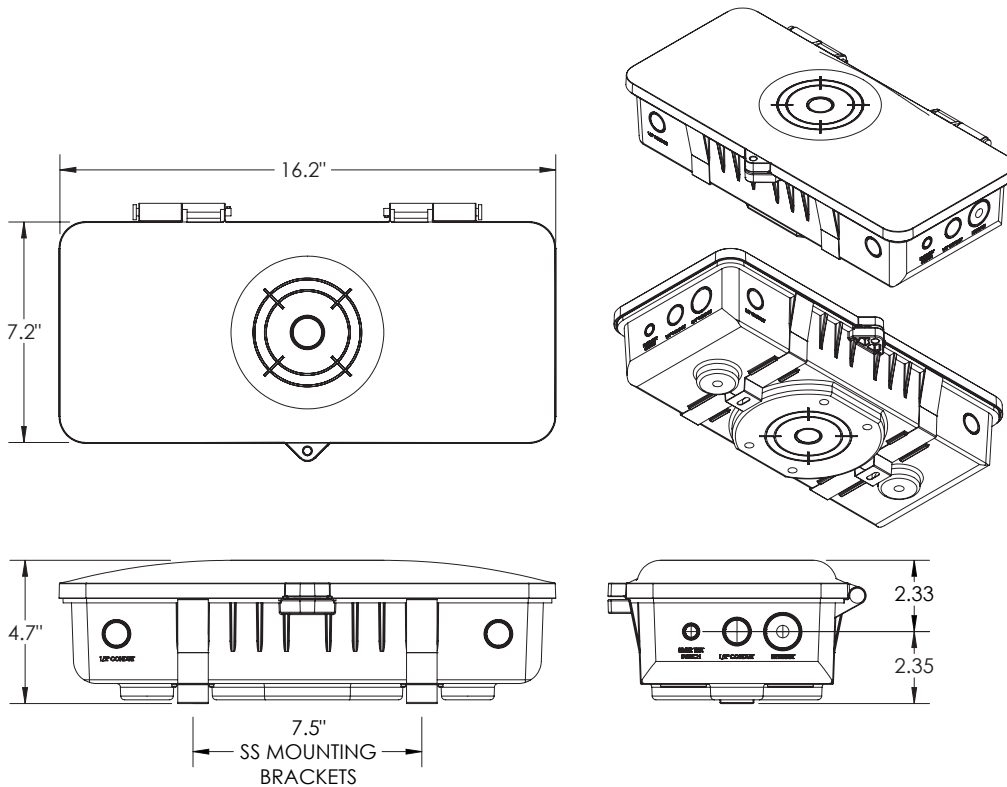

Due to continuous development and improvements, specifications are subject to change without notice. FC Lighting reserves the right to change lab test details or specifications without notice. Product use certifies agreement to FC Lighting terms and conditions. FCC Series Cylinder Lights are engineered and produced in our Illinois manufacturing facility.