

FCW3700 Series - INSTALLATION INSTRUCTIONS

CAUTION: BEFORE CONNECTING THE FIXTURE TO A POWER SUPPLY, MAKE SURE THE POWER IS SWITCHED OFF.

Including: W3707, W3710, W3712, W3707p, W3710p, W3712p

DETAILED ILLUSTRATION



FC
LIGHTING

t 800.900.1730 f 630.889.8106
3609 Swenson Ave. St. Charles, IL 60174

GENERAL:

1. Before starting the installation, make sure all electricity has been turned off and electrical breaker has been locked out and tagged out.
2. To ensure the success of the installation, be sure to read these instructions and review the diagrams thoroughly before beginning.
3. All electrical connections must be in accordance with local codes, ordinances, or the National Electrical Code.
4. These fixtures are intended to be mounted to a Octagonal Box directly supported by the building structure.

NOTE: The important safeguards and instructions appearing in this manual are not meant to cover all possible conditions and situations that may occur.

INSTALLATION:

1. Make wiring connections inside the octagonal box (FIG. 1).
2. Loosen set screws to Mounting Bracket. **NOTE:** Do not remove screws.
3. Feed wires from octagonal box through Mounting Bracket.
4. Level mounting bracket. Install to octagonal box using flat headed screws (screws provided by others). (FIG. 2)

IMPORTANT: Do not deform bracket when tightening.

5. Position fixture onto mounting bracket.
6. Tighten set screws to hold fixture flush to wall. (FIG. 3)
8. Installer **MUST** add a bead of silicone where the edge of the Fixture meets the Mounting Surface.

NOTE: Fixtures are listed for installation with liquid tight or rigid wall conduit only. Fixtures installed without a silicone bead will void the warranty.

OPTIONAL: Mounting Bracket can be removed from backplate to add additional mounting screws.

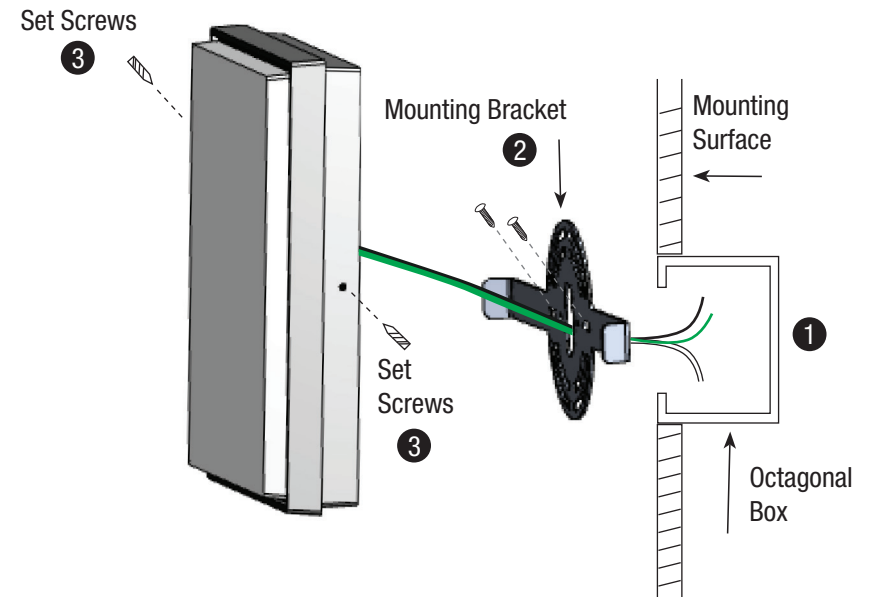

CONFIDENTIAL

THIS DOCUMENT IS THE PROPRIETARY PROPERTY OF FC LIGHTING, INC. ANY UNAUTHORIZED TRANSFER, USE OR REPRODUCTION IS STRICTLY PROHIBITED.

JO Rev. 0217

©2017 FC LIGHTING, INC.